

SHARP®

MODEL

AR-M256

AR-M316

DIGITAL MULTIFUNCTIONAL SYSTEM

OPERATION MANUAL
(for copier)

	Page
• BEFORE USING THE MACHINE	8
• COPY FUNCTIONS	21
• CONVENIENT COPY FUNCTIONS	35
• USER SETTINGS	52
• TROUBLESHOOTING AND MAINTENANCE	58
• PERIPHERAL DEVICES AND SUPPLIES	77
• APPENDIX	81

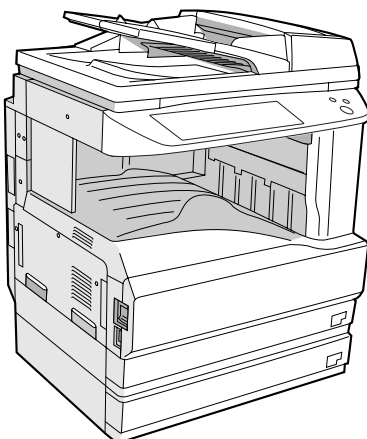

With the RSPF installed

Each instruction also covers the optional units used with these products.

Do not make copies of anything which is prohibited from copying by law. The following items are normally prohibited from copying by national law. Other items may be prohibited by local law.

- Money
- Stamps
- Bonds
- Stocks
- Bank drafts
- Checks
- Passports
- Driver's licenses

In some areas, the "POWER" switch positions are marked "I" and "O" on the copier instead of "ON" and "OFF".

If your copier is so marked, please read "I" for "ON" and "O" for "OFF".

Caution!

For a complete electrical disconnection, pull out the main plug.

The socket-outlet shall be installed near the equipment and shall be easily accessible.



Warning

This is a Class A product. In a domestic environment this product may cause radio interference in which case the user may be required to take adequate measures.

Shielded interface cables must be used with this equipment to maintain compliance with EMC regulations.

Required in Appendix ZB of BS EN 60950 — United Kingdom

MAINS PLUG WIRING INSTRUCTIONS

The mains lead of this equipment is already fitted with a mains plug which is either a non-rewireable (moulded) or a rewireable type. Should the fuse need to be replaced, a BSI or ASTA approved fuse to BS1362 marked  or  and of the same rating as the one removed from the plug must be used.

Always refit the fuse cover after replacing the fuse on the moulded plug. Never use the plug without the fuse cover fitted.

In the unlikely event of the socket outlet in your home not being compatible with the plug supplied either cut-off the moulded plug (if this type is fitted) or remove by undoing the screws if a rewireable plug is fitted and fit an appropriate type observing the wiring code below.

DANGER: The fuse should be removed from the cut-off plug and the plug destroyed immediately and disposed of in a safe manner. Under no circumstances should the cut-off plug be inserted elsewhere into a 13A socket outlet as a serious electric shock may occur.

To fit an appropriate plug to the mains lead, follow the instructions below:

IMPORTANT: The wires in this mains lead are coloured in accordance with the following code:

GREEN-AND-YELLOW:	Earth
BLUE:	Neutral
BROWN:	Live

As the colours of the wires in this mains lead may not correspond with coloured markings identifying the terminals in your plug, proceed as follows:

The wire which is coloured **GREEN-AND-YELLOW** must be connected to the terminal in the plug which is marked with the letter **E**, or by the safety earth symbol , or coloured green or green-and-yellow.

The wire which is coloured **BLUE** must be connected to the terminal which is marked with the letter **N** or coloured black.

The wire which is coloured **BROWN** must be connected to the terminal which is marked with the letter **L** or coloured red.

If you have any doubt, consult a qualified electrician.

WARNING: THIS APPARATUS MUST BE EARTHED.

CONTENTS

CAUTIONS	3
● CAUTIONS ON USING THE MACHINE.....	3
● IMPORTANT POINTS WHEN SELECTING AN INSTALLATION SITE	3
● CAUTIONS ON HANDLING THE MACHINE.....	4
● LASER INFORMATION	4
● ENVIRONMENTAL INFORMATION.....	5
USING THE MANUAL	5
● ABOUT THE OPERATION MANUALS.....	5
● THE MEANING OF "R" IN ORIGINAL AND PAPER SIZE INDICATIONS	6
● CONVENTIONS USED IN THIS MANUAL.....	6
MAIN FEATURES	7

1 BEFORE USING THE MACHINE

PART NAMES AND FUNCTIONS	8
● OPERATION PANEL.....	10
● TOUCH PANEL	11
POWER ON AND OFF	13
● POWER ON.....	13
● POWER OFF	13
● INITIAL SETTINGS.....	14
● POWER SAVE MODES.....	14
LOADING PAPER	15
● PAPER.....	15
● LOADING PAPER.....	17
● CHANGING A TRAY'S PAPER TYPE AND PAPER SIZE SETTINGS.....	19

2 COPY FUNCTIONS

MAIN SCREEN OF COPY MODE	21
NORMAL COPYING	22
● COPYING FROM THE DOCUMENT GLASS	22
● COPYING FROM THE RSPF	23
● POINTS TO NOTE WHEN MAKING COPIES	24
● BYPASS FEED (special paper)	26
AUTOMATIC TWO-SIDED COPYING	27
● USING THE DOCUMENT GLASS.....	27
● USING THE RSPF.....	28
EXPOSURE ADJUSTMENT	29
● SELECTING THE ORIGINAL IMAGE TYPE AND MANUALLY ADJUSTING THE EXPOSURE.....	29
REDUCTION/ENLARGEMENT/ZOOM	30
● AUTOMATIC RATIO SELECTION	30
● MANUAL RATIO SELECTION.....	31
● SELECTING THE VERTICAL AND HORIZONTAL COPY RATIOS SEPARATELY (XY ZOOM copying).....	32
INTERRUPTING A COPY RUN	34

3 CONVENIENT COPY FUNCTIONS

COPY FINISHING FUNCTIONS	35
● SORT COPY.....	35
● GROUP COPY.....	35
● OFFSET FUNCTION	35
● STAPLE SORT (when the finisher (AR-FN5A) is installed)	37
● ORIENTATION OF THE ORIGINAL AND STAPLING POSITIONS.....	37
SPECIAL MODES	39
● GENERAL PROCEDURE FOR USING THE SPECIAL FUNCTIONS.....	40
● MARGIN SHIFT COPY	41
● ERASE COPY.....	42
● DUAL PAGE COPY	43
● PAMPHLET COPY	44
● JOB BUILD MODE.....	45
● MULTI SHOT COPY	46
● ORIGINAL SIZE.....	47
● COVER COPY	48
● CARD SHOT.....	50

4 USER SETTINGS

CUSTOM SETTINGS	52
● GENERAL PROCEDURE FOR CUSTOM SETTINGS	53
● SETTINGS	54
JOB PROGRAM MEMORY	55
● STORING A JOB PROGRAM.....	55
● EXECUTING A JOB PROGRAM	56
● DELETING A STORED JOB PROGRAM	56
AUDITING MODE	57
● COPYING WHEN AUDITING MODE IS ENABLED	57

5

TROUBLESHOOTING AND MAINTENANCE

DISPLAY MESSAGES	59
TROUBLESHOOTING	61
MISFEED REMOVAL	65
● MISFEED REMOVAL GUIDANCE	65
● MISFEED IN THE RSPF.....	66
● MISFEED IN THE BYPASS TRAY	67
● MISFEED IN THE MACHINE.....	67
● MISFEED IN THE CENTRE TRAY	69
● MISFEED IN THE UPPER PAPER TRAY	69
● MISFEED IN THE LOWER PAPER TRAY	70
● MISFEED IN THE UPPER EXIT AREA (when a job separator tray kit or finisher (AR-FN5A) is installed)	71
● MISFEED IN AN OUTPUT TRAY (when a finisher (AR-FN5A) is installed)	71
REPLACING THE TONER CARTRIDGE	73
STAPLE CARTRIDGE REPLACEMENT	74
● STAPLE JAM REMOVAL	75
CHECKING THE TONER QUANTITY AND TOTAL COUNT	75
CLEANING THE MACHINE	76
● DOCUMENT GLASS AND DOCUMENT COVER/RSPF.....	76
● THE BYPASS TRAY PAPER FEED ROLLER	76

6

PERIPHERAL DEVICES AND SUPPLIES

PERIPHERAL DEVICES	77
● FINISHER (AR-FN5A)	78
● 500-SHEET PAPER FEED UNIT/ 2 x 500-SHEET PAPER FEED UNIT	79
● REVERSING SINGLE PASS FEEDER	80
STORAGE OF SUPPLIES	80
● PROPER STORAGE	80

7

APPENDIX

SPECIFICATIONS	81
MATERIAL SAFETY DATA SHEET	83
INDEX	91
● INDEX BY PURPOSE.....	94

CAUTIONS

Follow the cautions below when using this machine.

CAUTIONS ON USING THE MACHINE

⚠ Warning:

- The fusing area is hot. Exercise care in this area when removing misfed paper.
- Do not look directly at the light source. Doing so may damage your eyes.

⚠ Caution:

- Do not switch the machine rapidly on and off. After turning the machine off, wait 10 to 15 seconds before turning it back on.
- Machine power must be turned off before installing any supplies.
- Place the machine on a firm, level surface.
- Do not install the machine in a humid or dusty location.
- When the machine is not used for a long time, for example, during prolonged holidays, turn the power switch off and remove the power cord from the outlet.
- When moving the machine, be sure to turn the power switch off and remove the power cord from the outlet.
- Do not cover the machine with a dust cover, cloth or plastic film while the power is on. Doing so may prevent heat dissipation, damaging the machine.
- Use of controls or adjustments or performance of procedures other than those specified herein may result in hazardous laser radiation exposure.
- The socket-outlet should be installed near the machine and should be easily accessible.
- Do not throw the toner cartridge into a fire. Toner may fly and cause burns.
- Store toner cartridges out of the reach of small children.

IMPORTANT POINTS WHEN SELECTING AN INSTALLATION SITE

Improper installation may damage the machine. Please note the following during initial installation and whenever the machine is moved.



If the machine is moved from a cool place to a warm place, condensation may form inside the machine. Operation in this condition will cause poor copy quality and malfunctions. Leave the machine at room temperature for at least 2 hours before use.

Do not install your machine in areas that are:

- damp, humid, or very dusty



- exposed to direct sunlight

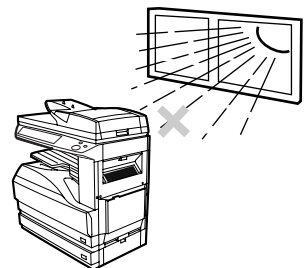

- poorly ventilated

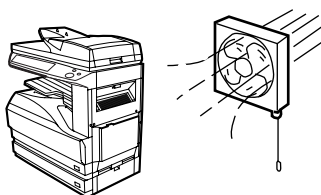

- subject to extreme temperature or humidity changes, e.g., near an air conditioner or heater.

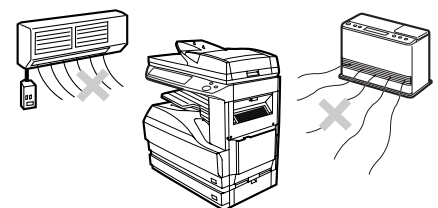

The machine should be installed near an accessible power outlet for easy connection and disconnection.

Be sure to connect the power cord only to a power outlet that meets the specified voltage and current requirements. Also make certain the outlet is properly grounded.



Connect the machine to a power outlet which is not used for other electric appliances. If a lighting fixture is connected to the same outlet, the light may flicker.

Be sure to allow the required space around the machine for servicing and proper ventilation.

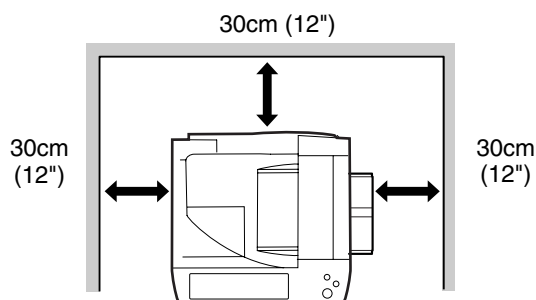

A small amount of ozone is produced within the machine during operation. The emission level is insufficient to cause any health hazard.

Note:

The present recommended long term exposure limit for ozone is 0.1 ppm (0.2 mg/m³) calculated as an 8 hr. time-weighted average concentration.

However, since the small amount that is emitted may have an objectionable odor, it is advisable to place the machine in a ventilated area.

CAUTIONS ON HANDLING THE MACHINE

Observe the following precautions when handling the machine to maintain top performance.

Do not drop the machine, subject it to shock or strike it against any object.

Store spare toner cartridges in a cool dry place without removing from the package before use.

- If they are exposed to direct sunlight or excessive heat, poor copies may result.

Do not touch the photoconductive drum (green portion).

- Scratches or smudges on the drum will cause dirty copies.

LASER INFORMATION

Wave length	785 nm +10 nm -15 nm
Pulse times	North America: 25 cpm model: (6.213 μs)/7 mm 31 cpm model: (7.385 μs)/7 mm Europe: 25 cpm model: (6.213 μs)/7 mm 31 cpm model: (7.385 μs)/7 mm
Output power	Max. 0.9 mW

ENVIRONMENTAL INFORMATION



Products that have earned the ENERGY STAR® are designed to protect the environment through superior energy efficiency.

USING THE MANUAL

This machine has been designed to provide convenient copying features in a minimum amount of office space and with maximum operational ease. To get full use of all machine features, be sure to familiarise yourself with this manual and the machine. For quick reference during machine use, keep this manual in a handy location.

ABOUT THE OPERATION MANUALS

The operation manuals for the machine are as follows:

Operation Manual for copier (this manual)

This manual contains explanations of the product and procedures for using the machine as a copier.

Online manual (for printer)

This manual is on the CD-ROM, and explains the procedures for using the machine as a printer, network printer, and network scanner.

Software setup guide (for printer)

This manual contains instructions for installing the software that allows the machine to be used with your computer and procedures for establishing initial printer settings.

Operation manual (for network scanner) (When the network scanner is installed.)

This manual contains explanations of the product and procedures for using the machine as a network scanner.

Key operator's guide

This explains key operator programs for machine management and copier related functions. Key operator programs for the fax functions are explained in the operation manual for facsimile.

THE MEANING OF "R" IN ORIGINAL AND PAPER SIZE INDICATIONS

An "R" appearing at the end of an original or paper size (A4R, A5R, 5-1/2" x 8-1/2"R, 8-1/2" x 11"R, etc.) indicates that the original or paper is oriented horizontally as shown below.

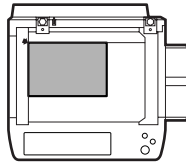

<Horizontal (Landscape) orientation>

Sizes that can be placed only in the horizontal (landscape) orientation (B4, A3, 8-1/2" x 14", 11" x 17"), do not contain the "R" in their size indication.

CONVENTIONS USED IN THIS MANUAL



Warning Warns that injury may result if the contents of the warning are not properly followed.



Caution Cautions that damage to the machine or one of its components may result if the contents of the caution are not properly followed.



Note Notes provide useful information on the specifications, functions, performance, and operation of the machine.

Explanation of words and illustration

- This operation manual refers to the Reversing Single Pass Feeder as the "RSPF".
- The illustrations in this manual show the AR-M256/AR-M316 with the optional reversing single pass feeder (AR-RP7) and the optional job separator tray kit (AR-TR3) installed.
The appearance of your machine may be different depending on the model and options installed, however, the basic operations are the same.
- For peripheral devices that can be installed, see "PERIPHERAL DEVICES" (p.77).
- The peripheral devices are generally optional, however, some models include certain peripheral devices as standard equipment.
- Some functions cannot be used on certain models.

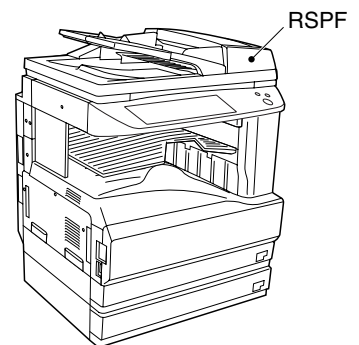

AB series (metric) and inch series references

Both specifications are quoted where applicable.

For example:

Page 15 A5 to A3 (5-1/2" x 8-1/2" to 11" x 17")

Page 81 25%, 50%, 70%, 81%, 86%, 100%, 115%, 122%, 141%, 200%, 400%
(25%, 50%, 64%, 77%, 100%, 121%, 129%, 200%, 400%)

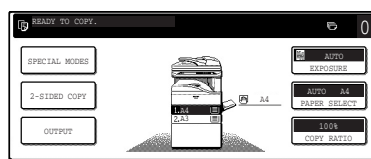

[AB series]

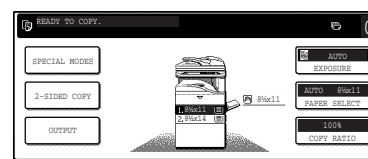

[Inch series]

Although AB series size indications are shown on the operation panel of this manual, inch series indications are displayed on the inch series machines.

MAIN FEATURES

High-speed laser copying

- First-copy time* is only 4.8 seconds.
- Copying speed is 25 copies/min. (AR-M256) or 31 copies/min. (AR-M316) This is ideal for business use and provides a big boost to workplace productivity.
* First-Copy time may vary depending on the power-supply voltage, ambient temperature, and other operating conditions.

High-quality digital image

- In addition to automatic exposure adjustment, three original type modes are available: "TEXT mode" for text-only originals, "TEXT/PHOTO mode" for mixed text and photo originals, and "PHOTO mode" for photos. The exposure can be manually adjusted to 5 levels in each mode.

Enhanced copying features

- Zoom copies can be made from 25% to 400% in increments of 1%.
- Continuous copying of up to 999 copies is possible.
- Automatic two-sided copying can be performed.
- Useful special features such as erase, margin shift, 2 in 1 and 4 in 1, pamphlet copy, dual page copy and cover copy are available.

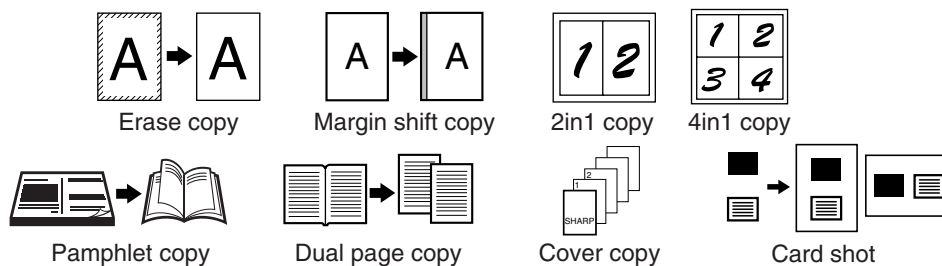

- Key operator programs allow the setting or modification of functions to meet your specific needs. The key operator programs can also be used to enable audit mode, which allows the machine administrator to control use of the machine.

Black and white LCD touch panel makes it easy to operate the machine

- Employing a backlit black and white LCD display, the touch panel provides step-by-step guidance for each function of the machine. The touch panel even provides instructions for removing paper misfeeds and other problems that occur.

Environment and people friendly design

- Preheat and auto power shut-off modes are provided to reduce power consumption when the machine is not in use.
- A universal design has been implemented in the product whereby the height of the operation panel and shape of the keys are designed to be usable by as many people as possible.

1

Chapter 1

BEFORE USING THE MACHINE

This chapter contains basic information that should be read before using the machine.

PART NAMES AND FUNCTIONS

Exterior

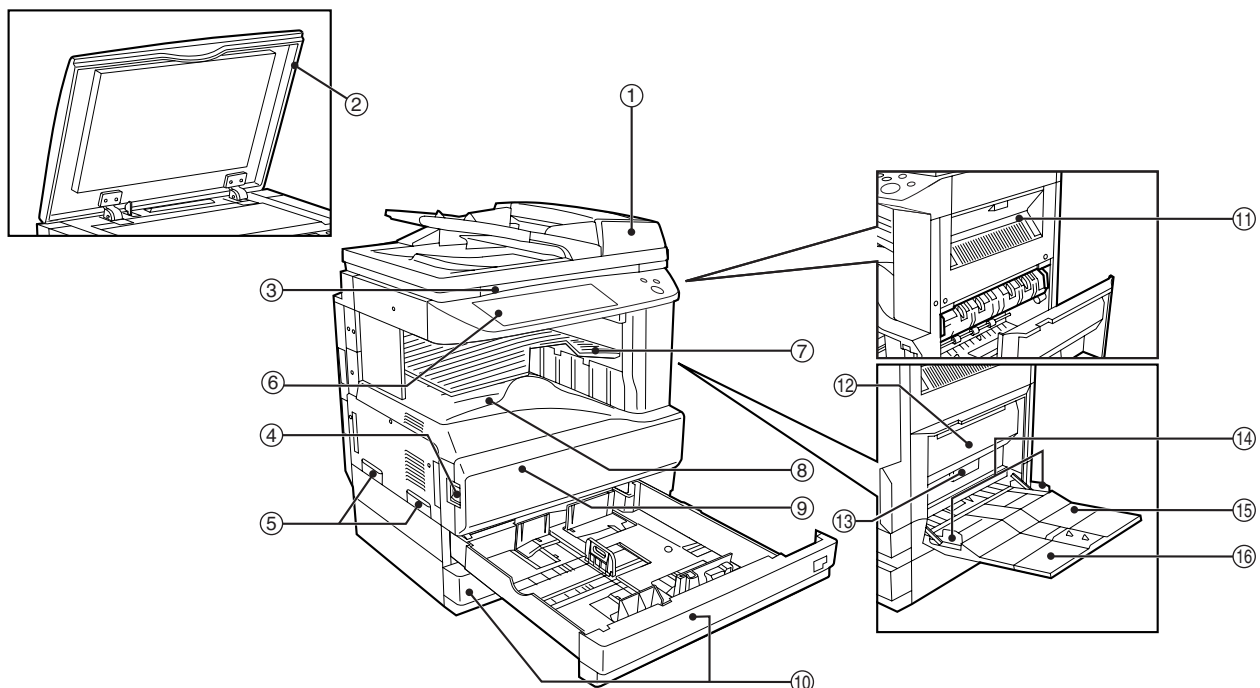

- ① **Reversing single pass feeder (RSPF) (optional)**
Place the original(s) that you wish to scan face up here. (p.23)
- ② **Document cover (optional)**
Place an original on the document glass and close the document cover before copying starts.
- ③ **Document glass**
Place an original that you wish to scan face down here. (p.22)
- ④ **Power switch**
Press to turn the machine power on and off. (p.13)
- ⑤ **Handles**
Use to move the machine.
- ⑥ **Operation panel**
Contains operation keys and the touch panel. (p.10)
- ⑦ **Job separator tray (upper tray) (optional)**
Print jobs and received faxes are delivered to this tray.
- ⑧ **Centre tray**
Finished copies are delivered to the centre tray.
- ⑨ **Front cover**
Open to remove paper misfeeds and perform machine maintenance. (p.67)
- ⑩ **Paper trays**
Each tray holds 500 sheets of copy paper. (p.15)
- ⑪ **Upper right side cover**
Open to remove misfeeds when an optional job separator tray kit or a optional finisher is installed. (p.71)
- ⑫ **Side cover**
Open to remove misfeeds. (p.67)
- ⑬ **Side cover handle**
Pull to open the side cover. (p.67)
- ⑭ **Bypass tray paper guides**
Adjust to the width of the paper. (p.18)

Interior

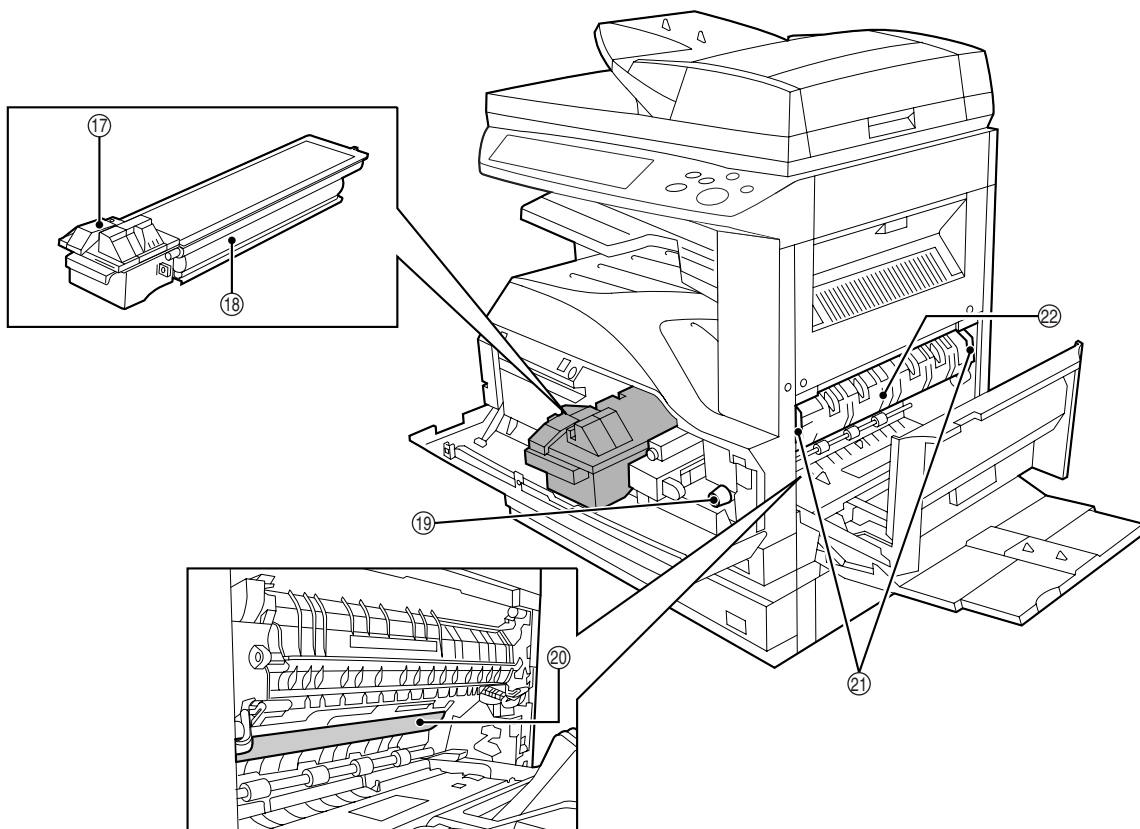

- ⑮ **Bypass tray**
Regular paper and special paper (such as transparency film) can be fed from the bypass tray. (p.18)
- ⑯ **Bypass tray extension**
Pull out the bypass tray extension before placing paper in the bypass tray. (p.18)
- ⑰ **Toner cartridge lock release lever**
Use to unlock the toner cartridge. (p.73)
- ⑱ **Toner cartridge**
Contains toner. (p.73)
- ⑲ **Roller rotating knob**
Turn to remove misfed paper. (p.67)
- ⑳ **Photoconductive drum**
Copy images are formed on the photoconductive drum.



Caution Do not touch the photoconductive drum (green portion). Doing so may damage the drum and cause smudges on copies.

- ㉑ **Fusing unit release levers**
To remove a paper misfed in the fusing unit, push up on these levers and remove the paper. (p.68)



Warning The fusing unit is hot. Do not touch the fusing unit when removing misfed paper. Doing so may cause a burn or injury.

- ㉒ **Fusing unit paper guide**
Open to remove misfed paper. (p.68)



Note The model name is on the front cover of the machine.

OPERATION PANEL

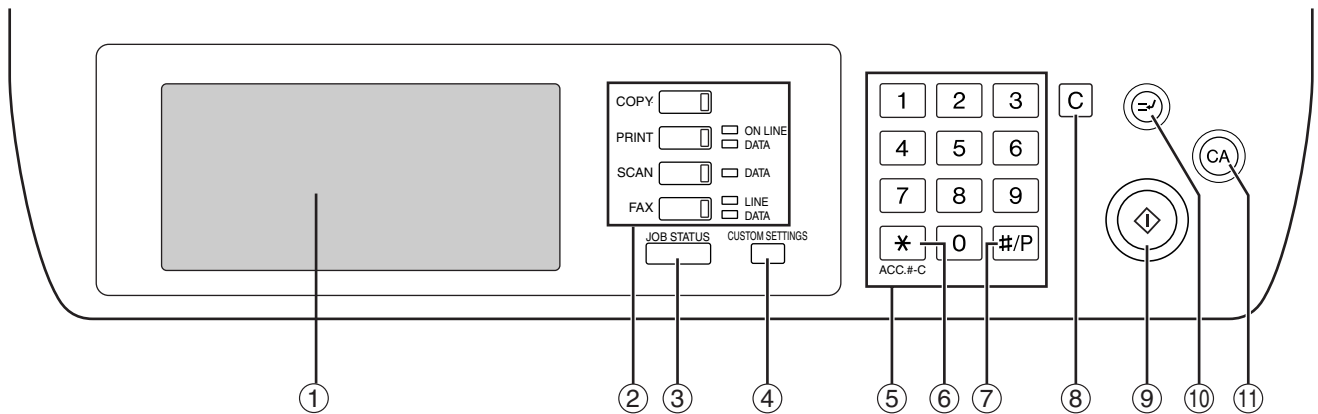

① Touch panel

The machine status, messages and touch keys are displayed on the panel. The display will show the status of printing, copying or network scanning according to the mode that is selected. For details see the next page.

② Mode select keys and indicators

Use to change modes and the corresponding display on the touch panel.

[COPY] key

Press to select copy mode.

[PRINT] key/ONLINE indicator/ DATA indicator

Press to select print mode.

- **ONLINE indicator**

Print jobs can be received when this indicator is lit.

- **DATA indicator**

A print job is in memory. The indicator lights steadily while the job is held in memory, and blinks while the job is printed.

[SCAN] key/DATA indicator (When the network scanner option is installed.)

Press to select network scan mode when the network scanner option is installed.

- **DATA indicator**

Lights steadily or blinks while a scanned image is being sent.

(See "Operation manual (for network scanner)".)

[FAX] key/LINE indicator/DATA indicator (When the fax option is installed.)

Press to select fax mode when the fax option is installed.

- **LINE indicator**

this lights up while faxes are being sent or received.

- **DATA indicator**

Blinks when a fax has been received to memory and lights steadily when a fax is waiting in memory for transmission.

(See operation manual for facsimile.)

③ [JOB STATUS] key

Press to display the current job status. (p.12)

④ [CUSTOM SETTINGS] key

Use to adjust various settings of the machine including the contrast of the touch panel and key operator programs. (p.53)

⑤ Numeric keys

Use to enter numeric values for various settings.

⑥ [ACC.#-C] key ([*])

When auditing mode is enabled, press this key after finishing a job to return the machine to account number entry standby.

⑦ [# / P] key ([# / P])

Use this key to execute a job program in copy mode.

The key is also used to dial in fax mode.

⑧ [CLEAR] key ([C])

Press to clear a copy number setting or cancel a job.

⑨ [START] key ([⊕])

Press in copy mode, scanner mode, or fax mode to begin copying, network scanning, or faxing.

This key blinks when auto power shut mode has activated. Press the key to return to normal operation.

⑩ [INTERRUPT] key ([⊖])

Use to perform an interrupt copy job. (p.34)

⑪ [CLEAR ALL] key ([CA])

Resets the settings to the initial settings.

TOUCH PANEL

Using the touch panel

[Example 1]

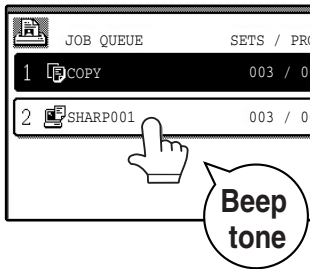

Items on the touch panel are selected by touching the key associated with the item. A beep will sound to confirm that the item was selected and the key will be highlighted.

* A double-beep is sounded when an invalid key is touched.

[Example 2]

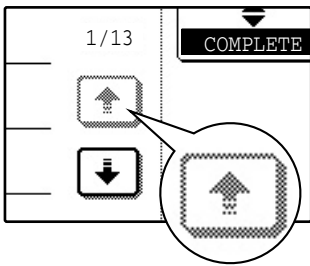

Keys which are greyed out cannot be selected.

The confirmation beeps can be disabled in the key operator programs. (See "Key operator's guide".)

The touch panel screens shown in this manual are printed images and may differ from the actual screens.

Selecting a function

[Example 1]

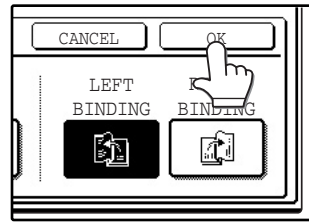

Items which are highlighted at the time a screen appears are already selected and will take effect when the [OK] key is touched.

[Example 2]

If you need to cancel a selection, simply press the key once again so that it is not highlighted.

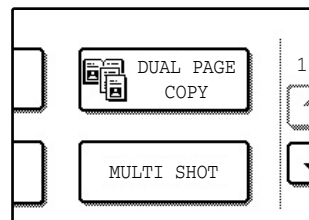
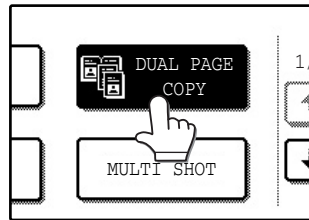

The key is no longer highlighted and the selection is cancelled.

[Example 3]

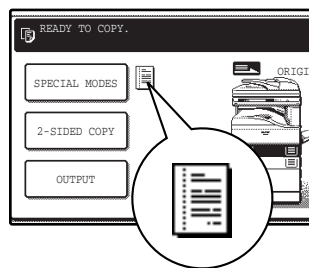

When the machine is used in copy mode or fax mode and a special mode is selected, a icon representing the feature will appear on the touch panel. If this icon is touched, the setting screen of the function (or a menu screen) will appear, allowing the settings to be checked, adjusted, or cancelled.

Job status screen (common to copy, print, network scan and fax)

This screen appears when the [JOB STATUS] key on the operation panel is pressed.



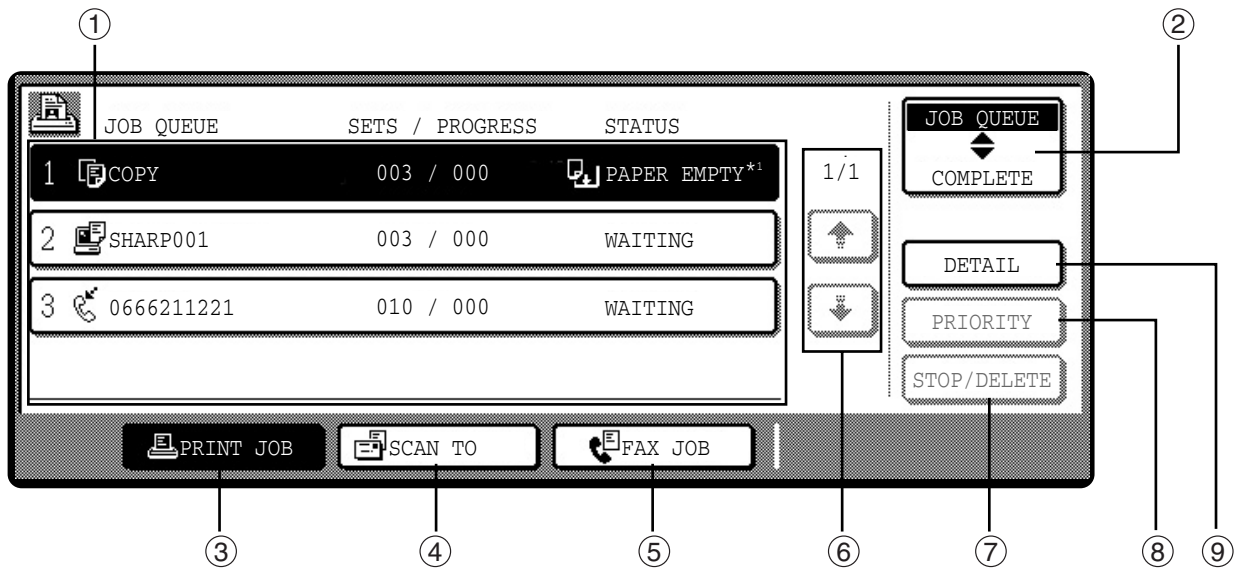

A job list showing the current job and the stored jobs or a list showing completed jobs can be displayed.

The contents of jobs can be viewed and jobs can be deleted from the queue. The following screen shows the job queue for print jobs.



① Job list

Shows stored jobs and the job currently being executed. Touch one of keys ③ to ⑤ in the above illustration to select the type of job. The icon next to each job name indicates the mode of the job as follows:

- | | |
|--|---|
|  Copy mode |  Printer mode |
|  Network scanner mode | |
|  Fax mode (Send jobs) |  Fax mode (Receive jobs) |

The jobs in the job list appear in the form of keys. To give priority to a job or pause or delete a job, touch the key of the job and then use the key described in ⑦ or ⑧.

*1: "PAPER EMPTY" in the job status display

"PAPER EMPTY" in the job status display indicates that the machine is out of the specified size of paper. Add the specified size of paper. If the specified size of paper is not available and you are in printer mode, another size of paper can be loaded in the bypass tray to allow printing to take place. (See the "Online manual".)

② Mode switching keys

Use to select the job list mode: "JOB QUEUE" (Stored/currently executing jobs) or "COMPLETE" (Finished jobs).

"JOB QUEUE":

Shows jobs that have been stored and the job that is currently being executed.

"COMPLETE":

Shows the jobs that have been finished. Note that copy jobs do not appear in this list.

If the power is turned off, or if auto power shut-off mode activates when there are no jobs, the jobs in the "COMPLETE" list will be erased.

③ [PRINT JOB] key

Use to view the list of output jobs for all modes (print, copy, and fax).

④ [SCAN TO] key

Displays a network scanner job (When the network scanner function is installed.).

⑤ [FAX JOB] key

This displays stored fax jobs and the fax job currently being executed (When the fax option is installed.).

⑥ Display switching keys

Use to change the page of the displayed job list.

⑦ [STOP/DELETE] key

Use to pause or delete a job currently being executed, or to delete a stored job. Copy jobs and received faxes cannot be paused or deleted with this key. Copy jobs can be cancelled by pressing the [CLEAR] key (C) or [CLEAR ALL] key (CA).

⑧ [PRIORITY] key

Touch this key after selecting a stored job in this [JOB QUEUE] list to print the job ahead of the other jobs.

⑨ [DETAIL] key

Shows information on the selected job. This cannot be used for a received fax.

POWER ON AND OFF

The power switch is located on the left side of the machine.



When the power switch is turned on, the machine starts up in the previously used mode. The following explanations assume that the previously used mode was copy mode.

POWER ON

Turn the power switch to the "ON" position.

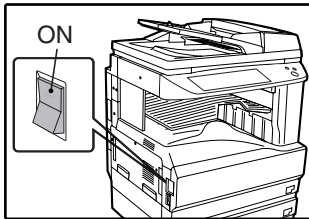

- When the power switch is turned to the "ON" position, the message "WARMING UP. A COPYING JOB CAN BE SET NOW." will appear in the message display and the machine will start warming up. When "READY TO COPY." appears, the machine is ready to copy. Copy settings can be selected during warm-up.
- If auditing mode is enabled, "ENTER YOUR ACCOUNT NUMBER." will appear. When a valid account number is entered, the account status will appear on the main screen for several seconds. Then copying can be performed. (See "Key operator's guide".)



If the fax option is installed, be sure to keep the power turned on. Faxes cannot be received when the power is turned off.

POWER OFF

When the machine is not used for a long time, be sure to turn it off.

Make sure that the machine is not in operation and then turn the power switch to the "OFF" position.

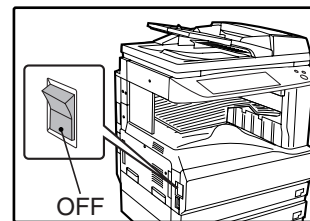

If the power switch is turned off while the machine is in operation, a misfeed may occur and the job that was in progress will be cancelled.

1

INITIAL SETTINGS

The machine reverts to the initial settings when it is first turned on, when the [CLEAR ALL] key (Ⓞ) is pressed, or the preset "auto clear time" elapses after the last copy is made in any mode. When the machine reverts to the initial settings, all settings and functions selected to that point are cancelled. The auto clear time can be changed in the key operator programs. (See the "Key operator's guide".)

The initial settings that appear in the display are shown below.

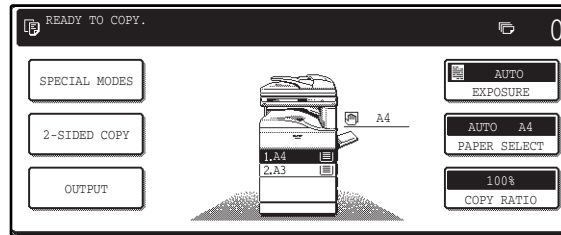

Functions and settings are explained based on the above screen as applicable.

Copy ratio: 100%, **Exposure:** Automatic, **Copy quantity:** 0, **Automatic two-sided:** One side to One side,
Auto paper selection: On,
Paper tray: Upper paper tray



The initial settings can be changed in the key operator programs. (See the "Key operator's guide".)
 For the initial settings (initial screen) of printer, fax, and scanner modes, see the operation manuals of those modes.

POWER SAVE MODES

The machine has two power save modes to reduce overall power consumption and thereby reduce the cost of operation. These modes help conserve natural resources and reduce environmental pollution. The two power save modes are "Preheat mode" and "Auto power shut-off mode".

The time settings for each mode can be changed in the key operator programs. (See the "Key operator's guide".)

Preheat mode

When the set time elapses, the temperature of the fusing unit is automatically lowered to reduce power consumption while on standby. The factory default setting is 15 minutes. To return to normal operation, touch any key on the operation panel. To make a copy when the machine is in this mode, simply select the desired copy selections and then press the [START] key (Ⓞ).

Auto power shut-off mode

When the set time elapses, the power to the fusing unit automatically turns off to reduce power consumption (This is based on the guidelines of the International Energy Star Program.). The factory default setting is 60 minutes. When the machine enters this mode, the touch panel screen turns off and only the [START] key (Ⓞ) blinks. To return to normal operation, press the [START] key (Ⓞ). To copy after warm-up starts, make desired copy selections and press the [START] key (Ⓞ). When the machine receives a fax or a print job, Auto power shut-off mode automatically deactivates and the machine returns to normal operation.

LOADING PAPER

When a tray runs out of paper, a message appears in the touch panel. Load paper in the tray.

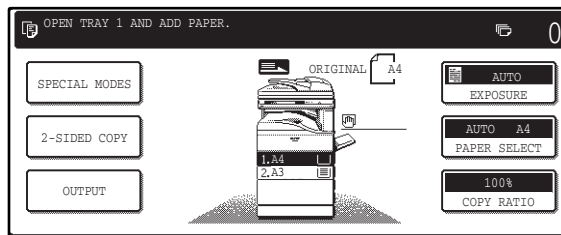

PAPER

The specifications for the types and sizes of paper that can be loaded in the paper trays are shown below. For best results, use only SHARP recommended paper.

Tray No.	Paper tray type	Paper type	Size	Weight	Capacity
1	Upper paper tray*1	Plain paper Letterhead paper Recycled paper Colour paper	A5 to A3 (5-1/2" x 8-1/2" to 11" x 17")	56 g/m ² to 105 g/m ² (15 lbs. to 28 lbs.)	500 sheets*4
2	Lower paper tray*2				
3	500-sheet paper feed unit/ Upper paper tray of 2 x 500-sheet paper feed unit				
4	Lower paper tray of 2 x 500-sheet paper feed unit				
	Bypass tray	Plain paper Letterhead paper Recycled paper Colour paper	A6 to A3 (5-1/2" x 8-1/2" to 11" x 17")	56 g/m ² to 128 g/m ² (15 lbs. to 34.5 lbs.) *3	100 sheets*4
		Thin paper		52 g/m ² to 56 g/m ² (14 lbs. to 15 lbs.)	100 sheets
		Heavy paper		Max. 200 g/m ² (54 lbs.)	30 sheets
		Labels			40 sheets
		Transparency film			40 sheets
		Envelope		International DL (110 x 220 mm) International C5 (162 x 229 mm) Commercial 10 (4-1/8" x 9-1/2")	

*1 A5 (5-1/2" x 8-1/2") size paper can only be loaded in tray 1 and the bypass tray.

*2 B5 size paper cannot be loaded in tray 2 (However, B5R paper can be loaded.).

*3 When loading paper larger than A4 (8-1/2" x 11") size, do not use paper of weight greater than 105 g/m² (28 lbs.).

*4 The number of sheets of paper which can be loaded varies depending on the weight of the paper.

Special papers

Follow these guidelines when using special papers.

Envelopes

Do not use the following envelopes (Misfeeds will occur.).

- Envelopes with metal tabs, clasps, strings, holes, or windows.
- Envelopes with rough fibres, carbon paper, or glossy surfaces.
- Envelopes with two or more flaps.
- Envelopes with tape, film, or paper attached to the flap.
- Envelopes with a fold in the flap.
- Envelopes with glue on the flap to be moistened for sealing.
- Envelopes with labels or stamps.
- Envelopes that are slightly inflated with air.
- Envelopes with glue protruding from the seal area.
- Envelopes with part of the seal area peeled off.

Letterhead paper

Letterhead paper is paper with information pre-printed at the top such as a company name and address.

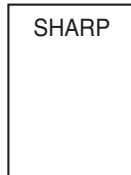

- Use SHARP recommended transparency film and label sheets. Using other than SHARP recommended paper may result in misfeeds or smudges on the output. If other than SHARP recommended media must be used, feed each sheet one at a time using the bypass tray (Do not attempt continuous copying or printing.).
- There are many varieties of special paper available on the market, and some cannot be used with this machine. Before using special paper, contact your authorised service representative.
- Before using other than SHARP recommended paper, make a test copy to see if the paper is suitable.

LOADING PAPER

Make sure that the machine is not copying, printing, or printing a received fax, and then follow these steps to load paper.

Loading the paper in the paper tray

1 Pull out the paper tray until it stops.

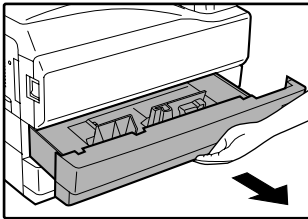

If you are loading the same size of paper as was loaded previously, go to step 4. If you are loading a different size of paper, continue with the following step.

2 Squeeze the lock lever of the front guide and slide the front guide to match the width of the paper.

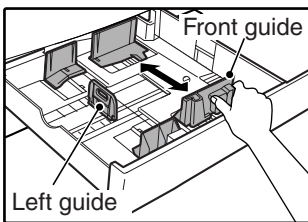

3 Move the left guide to the appropriate slot as marked on the tray.

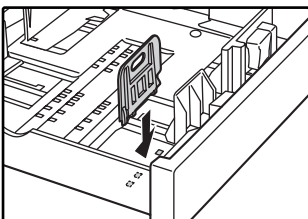

When using 11" x 17" copy paper, store the left front of the paper tray.

4 Fan the copy paper.

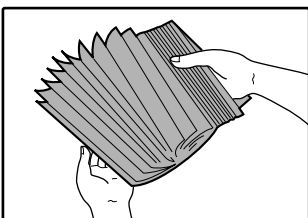

5 Load paper in the tray.

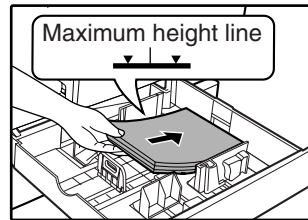

- Load the paper with the print side facing up.
- Insert the paper along the guides.
- The tray holds up to 500 sheets of 80g/m² (21 lbs.) paper.
- Do not load paper above the maximum height line.
- When adding paper, first remove any paper remaining in the tray, combine it with the paper to be added, and then reload as a single stack.

6 Push the paper tray firmly back into the machine.

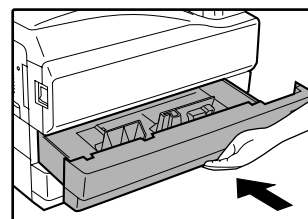

If you loaded a different size of paper that was loaded previously, place the appropriate paper size card in the front of the paper tray to indicate the new paper size.

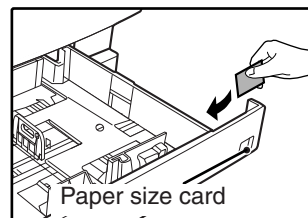

If you loaded a different size of paper that was loaded previously, go to "CHANGING A TRAY'S PAPER TYPE AND PAPER SIZE SETTINGS" (p.19).

Loading paper in the bypass tray

1 Unfold the bypass tray.

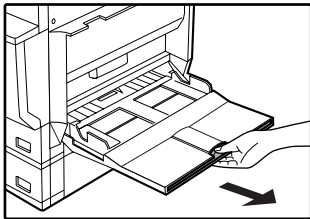
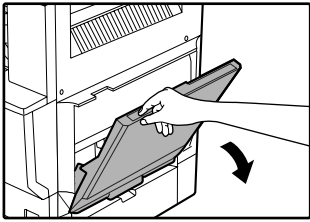

To enable correct detection of the paper size, be sure to pull out the bypass tray extension.

3 Insert the copy paper (print side down) all the way into the bypass tray.

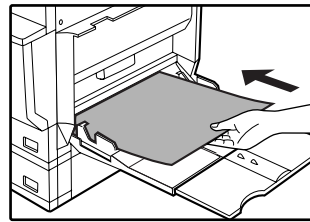

2 Set the paper guides to the copy paper width.

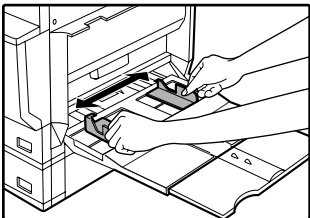

Important points when inserting paper in the bypass tray

- Be sure to place A6 size paper or envelopes horizontally as shown in the following diagram.
- Load the paper with the print side facing down.

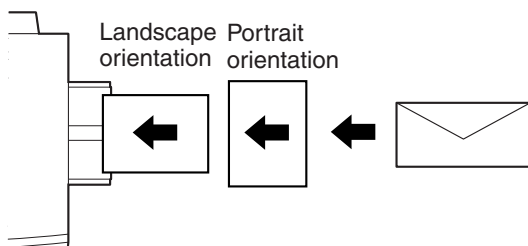

- When loading envelopes, make sure that they are straight and flat and do not have loosely glued construction flaps (not the closure flap).
- When adding paper, first remove any paper remaining in the bypass tray, combine it with the paper to be added, and then reload as a single stack. The paper to be added must be the same size and type as the paper already in the bypass tray.
- Do not use paper that is smaller than the original image. This may cause smudges or unclear images.
- Do not use paper that has already been printed on by a laser printer or plain paper fax machine. This may cause smudges or unclear images.

CHANGING A TRAY'S PAPER TYPE AND PAPER SIZE SETTINGS

When you change the paper in a tray, follow the steps below to change the tray's paper type and paper size settings. The settings cannot be changed when operation has stopped because the paper ran out or a misfeed occurred, or when an interrupt copy job is being performed.

Even in copy mode, the settings cannot be changed while a print job or received fax is being printed.



- A5 (5-1/2" x 8-1/2") size paper can only be set for tray 1.
- B5 size paper cannot be set for tray 2 (However, B5R size paper can be set.).
- Tray settings for trays other than the bypass tray can be prohibited in the key operator programs. (See the "Key operator's guide".)

1 Load paper in the tray as explained in "Loading the paper in the paper tray" (p.17).

2 Press the [CUSTOM SETTINGS] key.

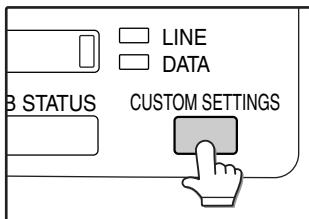

The custom settings menu screen will appear.

3 Touch the [TRAY SETTINGS] key.

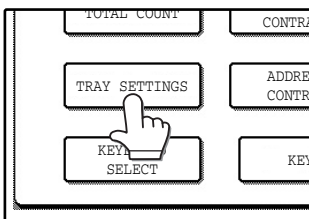

The tray settings screen will appear.

4 Select the tray in which you loaded paper.

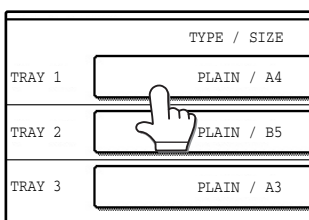

For the tray numbers, see "PAPER" (p.15). If the desired tray does not appear in the display, use the key or key to scroll until it appears.

5 Select the size and type of paper that is loaded in the tray.

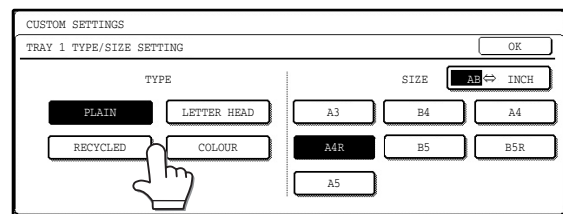

The currently selected paper type will be highlighted.

- To change the paper type selection, touch the appropriate type key.
- To change the paper size selection, touch the appropriate size key.
- To change the displayed size selections to inch sizes, touch [AB ↔ INCH].

6 Touch the [OK] key.

7 A message appears prompting you to check the paper in the tray. Check the paper and then touch the [OK] key.

You will return to the tray settings screen.

Setting the paper type in the bypass tray

Use either of the following two methods to set the bypass tray's paper type setting.

From the [CUSTOM SETTINGS] key

1 Load paper in the bypass tray as explained in "Loading paper in the bypass tray" (p.18).

2 Press the [CUSTOM SETTINGS] key.

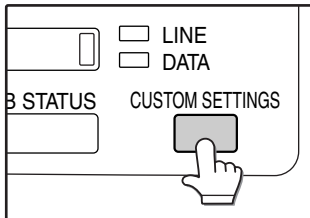

The custom settings menu screen will appear.

3 Touch the [TRAY SETTINGS] key.

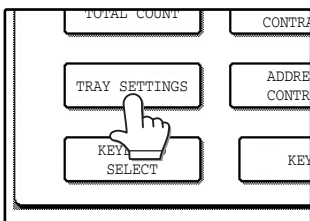

The tray settings screen will appear.

4 Touch the [BYPASS TRAY] key.

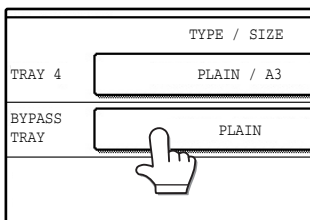

5 Select the type of paper that is loaded in the tray.

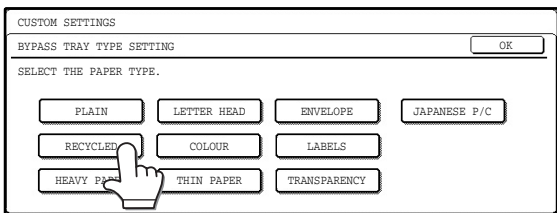

"JAPANESE P/C" refers to official postcards used in Japan.

6 Touch the [OK] key.

You will return to the tray settings screen.

From the [PAPER SELECT] key

1 Load paper in the bypass tray as explained in "Loading paper in the bypass tray" (p.18).

2 Touch the [PAPER SELECT] key.

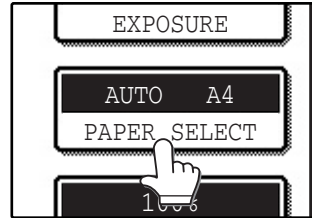

3 Touch the paper type selection key.

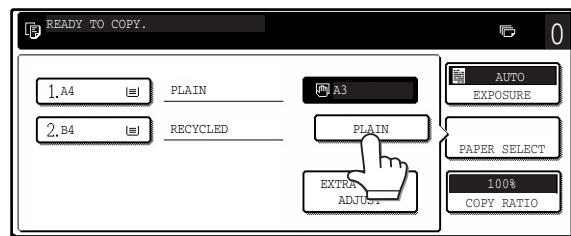

4 Select the paper type.

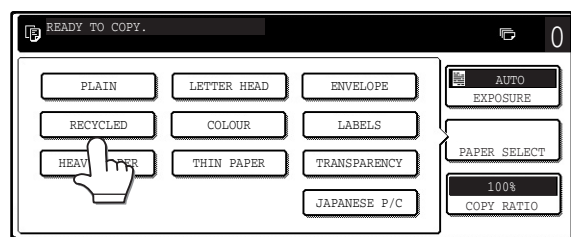

"JAPANESE P/C" refers to official postcards used in Japan.

5 Touch the [PAPER SELECT] key.

You will return to the main screen of copy mode.

This chapter explains basic copying functions such as normal copying, reduction or enlargement, and exposure adjustment.

MAIN SCREEN OF COPY MODE

The main screen of copy mode shows messages, keys, and settings that are used for copying. Touch a key to make a selection. The main screen of copy mode appears when the [COPY] key is pressed (Except when the custom settings screen appears.).

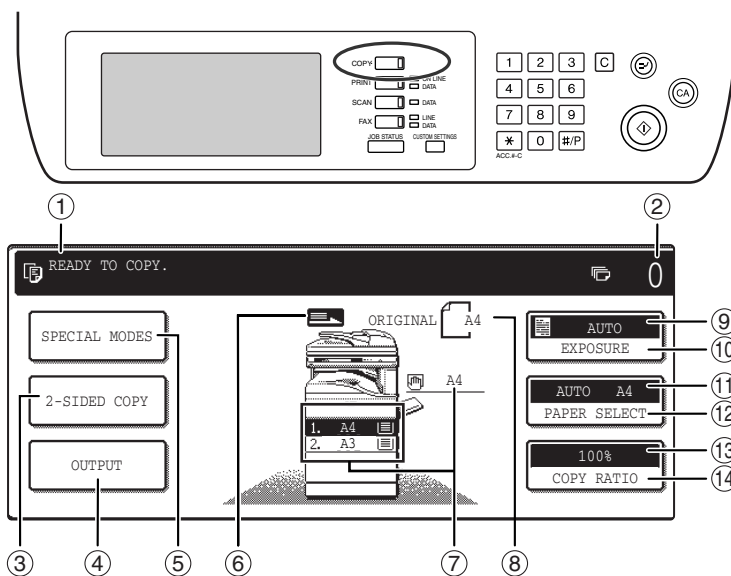

The screen will vary depending on the equipment installed.

- ① **Message display**
Status messages are displayed here.
- ② **Copy number display**
Displays the selected number of copies before the [START] key (⏻) is pressed or the number of remaining copies after the [START] key (⏻) is pressed. A single copy can be made when "0" is displayed.
- ③ **[2-SIDED COPY] key (p.27)**
Touch to open the duplex copy mode setting screen.
- ④ **[OUTPUT] key (p.35)**
Touch to select sort, group, staple sort, and other output settings.
- ⑤ **[SPECIAL MODES] key (p.39)**
Touch to open the special modes selection screen.
- ⑥ **Original feed display**
This appears when an original is placed in the RSPF.
- ⑦ **Paper size display**
This shows the location of the paper trays, the size of the paper in the trays. "≡" indicates whether or not there is paper. A paper tray can be touched to change the paper tray selection.
- ⑧ **Original size display**
Displays the original size only when an original is placed for copying.
- ⑨ **Exposure display**
Displays the icon of the selected exposure type and the exposure scale.
- ⑩ **[EXPOSURE] key (p.29)**
Use this key to adjust the copy exposure.
- ⑪ **Paper select display**
Displays the selected paper size. When auto paper select mode is selected, "AUTO" appears when auto paper select mode is selected.
- ⑫ **[PAPER SELECT] key (p.22, p.26)**
Use this key to select the paper size.
- ⑬ **Copy ratio display**
Displays the selected copy ratio.
- ⑭ **[COPY RATIO] key (p.31)**
Use this key to select the copy ratio.

NORMAL COPYING

COPYING FROM THE DOCUMENT GLASS



If "AUDITING MODE" (p.57) has been enabled, enter your 5-digit account number.

- 1 **Open the document cover/RSPF and place the original face down on the document glass.**

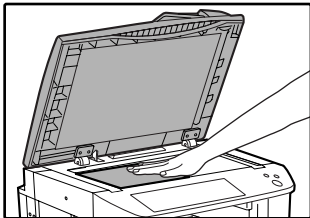

[How to place the original]

Align the corner of the original with the tip of the arrow (▲) at the left rear corner of the glass as shown in the illustration.

Original scale

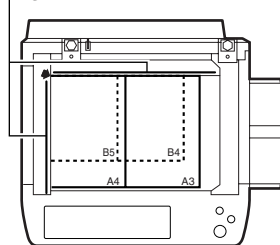

Original scale

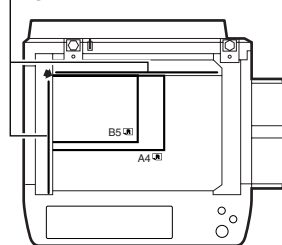

- 2 **Close the document cover/RSPF.**

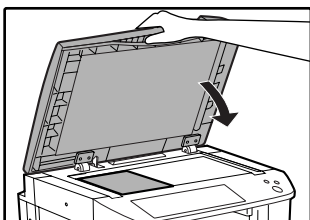

The original size appears in the touch panel. After placing the original, be sure to close the document cover/RSPF. If left open, parts outside of the original will be copied black, causing excessive use of toner.



If the original size is not automatically detected, manually set the original size. (p.47)

- 3 **Make sure that the same size of paper as the original is automatically selected.**

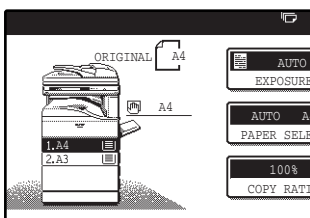

The selected tray is highlighted. If the tray contains a different size of paper than the original, "LOAD xxxx PAPER." will appear.

Even if the message above is displayed, copying can be performed using the selected paper tray.



- To load paper, see "LOADING PAPER" (p.15). If you change the paper size in the tray, you will also need to change the tray's paper type and paper size settings. (p.19)
- The paper types for the auto paper selection function can be selected, or the function disabled, in the key operator programs. (See the "Key operator's guide".)

Manually selecting the paper size (paper tray)

If auto paper selection is disabled in the key operator programs, or if you wish to use a different size of paper than the original, touch the [PAPER SELECT] key and select the paper tray with the desired paper size. (The selected paper will be highlighted and the paper selecting screen will close.)

To close the screen without selecting a paper size, touch the [PAPER SELECT] key again.

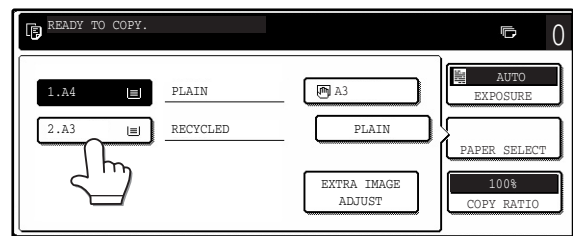

- 4 **Select the number of copies and any other desired copy settings, and then press the [START] key (⏻).**

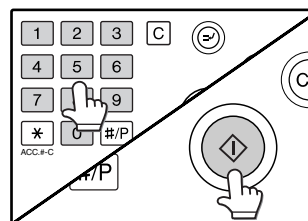

- The number in the copy quantity display will decrease by 1 each time a copy is made.
- If you are only making a single copy, the copy can be made with the copy number display showing "0".
- To clear a mistake, press the [CLEAR] key (C).



- Press the [CLEAR] key (C) to stop copying in the middle of a run.
- To repeat the same copy sequence for a different original, simply replace the original and press the [START] key (⏻).
- If copying stops because the tray has run out of paper, you can resume copying by touching the [PAPER SELECT] key and selecting the bypass tray or a paper tray that has the same size and type of paper loaded in the same orientation.

COPYING FROM THE RSPF



- If "AUDITING MODE" (p.57) is enabled, enter your 5-digit account number.
- If the RSPF is disabled in the key operator programs, the RSPF cannot be used. See the "Key operator's guide".

1 Make sure that an original has not been left on the document glass and then close the RSPF.

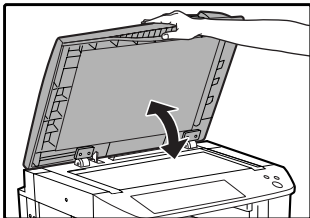

If an original remains on the document glass after a copy was made, "REMOVE THE ORIGINAL FROM THE DOCUMENT GLASS." will appear in the touch panel.

2 Adjust the original guides to the size of the original.

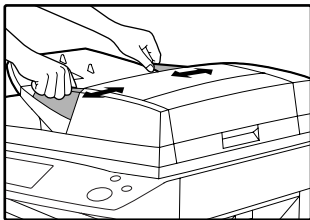

3 Place the originals face up in the document feeder tray.

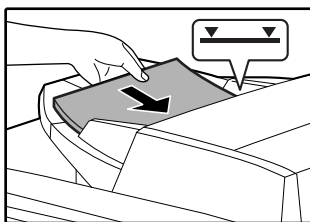

Insert the originals all the way into the feed slot. The original size appears in the touch panel.



- Up to 100 pages (90 g/m² (24 lbs.)) can be inserted at once.
- If the original size is not automatically detected, manually set the original size. (p.47)

4 Make sure that the same size of paper as the original is selected.

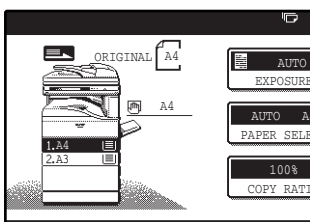

The selected tray is highlighted. If none of the trays have the same size of paper as the original, "LOAD xxxx PAPER." will appear.

Even if the message above is displayed, copying can be performed using the selected paper tray.



- To load paper, see "LOADING PAPER" (p.15). If you change the paper size in the tray, you will also need to change the tray's paper type and paper size settings. (p.19)
- If needed, manually select the paper tray that has the desired size of paper as explained on page 22.
- The paper types for the auto paper selection function can be selected, or the function disabled, in the key operator programs. (See the "Key operator's guide".)
- If the original size is larger than the paper size, the result of copying from the document glass may differ from the result of copying from the RSPF. (p.22)

5 Select the number of copies and any other desired copy settings, and then press the [START] key (⏻).

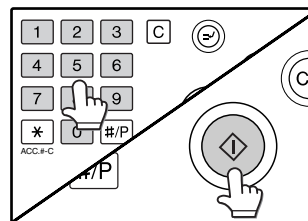

- The number in the copy quantity display will decrease by 1 each time a copy is made.
- If you are only making a single copy, the copy can be made with the copy number display showing "0".
- To clear a mistake, press the [CLEAR] key (⏻).



- Press the [CLEAR] key (⏻) to stop copying in the middle of a run.
- If copying stops because the tray has run out of paper, you can resume copying by touching the [PAPER SELECT] key and selecting the bypass tray or a paper tray that has the same size and type of paper loaded in the same orientation.

Stream feeding mode

If stream feeding mode is enabled in the key operator programs, "SET ORIGINALS FOR STREAM FEEDING." will appear in the touch panel for approximately 5 seconds after the originals are fed. Any new originals placed in the RSPF while this message appears will be fed and copied automatically.

Copying a large number of originals

Job Build mode is useful when you need to copy more originals that can be placed in the RSPF at once. For information on Job Build mode, see "JOB BUILD MODE" (p.45).

POINTS TO NOTE WHEN MAKING COPIES

Document glass and RSPF

- Paper in a different orientation from the original can be selected if the auto paper select or auto image function has been selected. In this case, the image of the original will be rotated.
- When copying a book or an original that has been folded or crumpled, press down gently on the document cover/RSPF. This will reduce shadow lines caused by uneven contact between the original and the document glass.
- When the centre tray counter function is enabled, the number of pages that can be delivered to the output tray is limited to 500 (A4 and 8-1/2" x 11" sizes only; the limit for all other sizes is 300 pages.). When the offset function is used, the limit is approximately 300 pages. When the limit is reached, copying stops and the [START] key (Ⓢ) light turns off. Remove the copies from the centre tray and then press the [START] key (Ⓢ) to resume copying. The centre tray counter function can be disabled in the key operator programs. (See the "Key operator's guide".)

Originals that can be used in the RSPF

A maximum of 100 sheet originals of equal size (A4, 90g/m² (8-1/2" x 11", 24 lbs.)) can be placed in the RSPF. Originals of different length can be placed together in the RSPF as long the widths are equal; however, some copy functions may not operate correctly.

Acceptable originals

Originals of size A5 to A3 (5-1/2" x 8-1/2" to 11" x 17") having a weight of 35g/m² to 128g/m² (9 lbs. to 34 lbs.) or 52g/m² to 105g/m² (14 lbs. to 28 lbs.) for two-sided originals can be used.

Other considerations

- Use originals that are within the specified size and weight ranges. Originals outside the specified ranges may cause misfeeds.
- Make sure that there are no paper clips or staples on the original.
- If an original has damp spots from correction fluid or ink, or glue from pasteups, be sure it has dried completely before using it to make a copy. Otherwise the interior of the RSPF or the document glass may become soiled.
- The following originals cannot be used. These may cause misfeeds, smudging, and unclear images.
 - Transparencies, tracing paper, other transparent or translucent paper, photographs
 - Carbon paper
 - Thermal paper
 - Originals that are creased, folded, or torn
 - Glued originals, cut-out originals
 - Originals with binder holes
 - Originals printed using an ink ribbon (thermal transfer printing), originals printed on thermal transfer paper

Removing the document cover

- To copy large originals like newspaper, remove the document cover.
- To remove it, open the document cover and lift it at a slightly backward angle. To replace the cover, do the reverse.
- The RSPF cannot be removed.

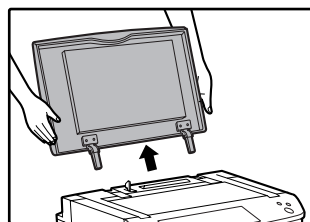

Copying originals of mixed length (Mixed feeding)

When using the RSPF, originals of mixed length can be fed together as long as the width of the originals is the same. To copy originals of mixed length, follow these steps:

1 Touch the [SPECIAL MODES] key.

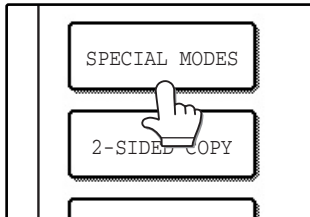

2 Touch the [↓] key and then the [ORIGINAL SIZE] key.

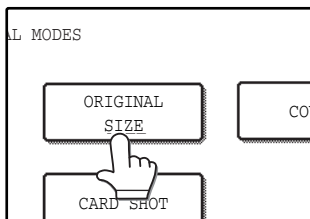

3 Select the "MIX SIZE ORIGINAL FEEDING MODE" checkbox.

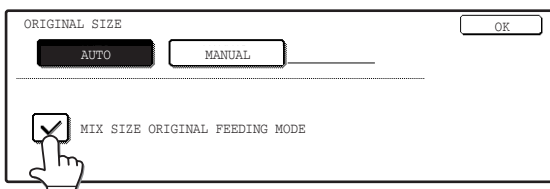

4 Touch the [OK] key.

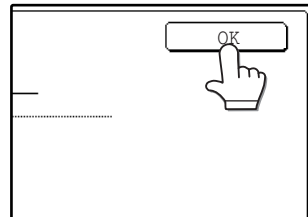

The setting is entered and you return to the main screen. The original size icon changes to () to indicate that mixed feeding is selected.



Note

When copying is started in mixed feeding mode, all originals are scanned before copying begins.

2

Automatic copy image rotation (Rotation copying)

If the originals are placed in a different orientation than the copy paper, the original image will be automatically rotated 90°. (When an image is rotated, a message will be displayed.) If a function is selected that is not suitable for rotation, such as enlarging the copy to greater than A4 (8-1/2" x 11") size or margin shift copy, rotation will not be possible.

[Example]

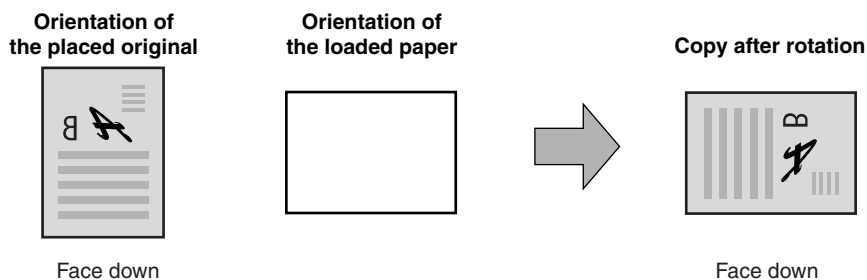

- This function operates in both the auto paper select and auto image modes. Rotation copying can be disabled in the key operator programs. (See the "Key operator's guide".)

BYPASS FEED (special paper)

The bypass tray must be used to feed special papers such as transparency film and labels. The bypass tray can also be used to feed standard copy paper.

1 Place the original(s). (p.22, p.23)

2 Insert the paper (print face down) all the way into the bypass tray.

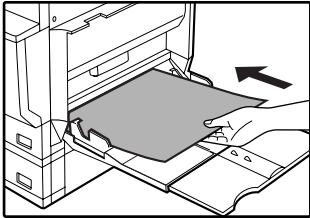

For paper that can be used in the bypass tray, see "PAPER" (p.15). To load paper, see "Loading paper in the bypass tray" (p.18).

4 Select the number of copies and any other desired copy settings, and then press the [START] key (⏏).

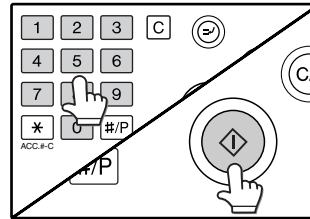

3 Touch the [PAPER SELECT] key or the tray in the image of the machine in the touch panel, and select the bypass tray.

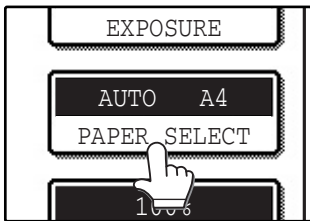

Set the type of paper that you loaded in the bypass tray. (p.20)

Shifting the starting position of copying

When copying on a special size of paper in the bypass tray, the starting position of printing can be shifted vertically for fine adjustment of the image position. To adjust the starting position of printing, follow the steps below. This function can only be used when feeding special sizes of paper from the bypass tray.

1 Touch the [PAPER SELECT] key and then touch the [EXTRA IMAGE ADJUST] key on the bypass tray.

2 Use the [▼] key or [▲] key to adjust the printing position, and then touch the [OK] key.

- The position can be adjusted from -10 mm to +10 mm in 0.5 mm (-0.5 inch to +0.5 inch in 0.02 inch) increments.
- When a setting from -10 mm to -0.5 mm (-0.5 inch to -0.02 inch) is selected, the starting position of printing is moved to front from the standard position. When a setting from +0.5 mm to +10 mm (+0.02 inch to +0.5 inch) is selected, the starting position of printing is moved to rear.

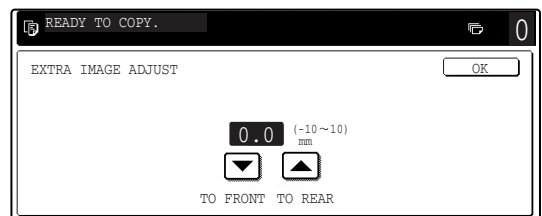

AUTOMATIC TWO-SIDED COPYING

Two originals can be automatically copied onto both sides of a single sheet of paper. When the RSPF is used, two-sided copies of two-sided originals can easily be made.

Original → Paper	
Document glass	One-sided original → Two sides (1 _h →2)
RSPF	One-sided original → Two sides (1 _h →2)
	Two-sided original → Two sides (2→2)
	Two-sided original → One side (2→1 _h)

2



- Paper sizes that can be used are A5, B5, B5R, A4, A4R, B4, and A3 (8-1/2" x 11", 8-1/2" x 11"R, 8-1/2" x 13", 8-1/2" x 14" and 11" x 17").
- When making two-sided copies on letterhead paper, place the side with the letterhead face down if using a tray, or face up if using the bypass tray (This is the opposite of normal.).
- Automatic two-sided copying is not possible on thick paper, thin paper, labels, transparency film, envelopes, and other special types of paper.
- Automatic two-sided copying can be disabled in the key operator programs. (See the "Key operator's guide".)
- When dual page copy (p.43) is selected, two-sided original to two sides or two-sided original to one side cannot be used.

USING THE DOCUMENT GLASS

1 Place the original on the document glass. (p.22)

2 Touch the [2-SIDED COPY] key.

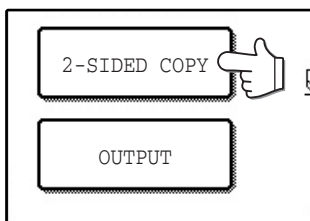

3 Touch the [One-sided to two-sided copy] key.

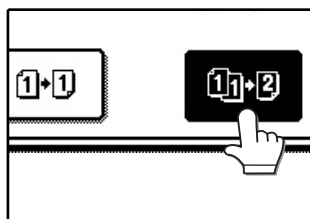

Touch the [BINDING CHANGE] key when making the tablet binding, or when making automatic two-sided copies of a one-sided A3 or B4 (11" x 17" or 8-1/2" x 14") size portrait original, touch the [BINDING CHANGE] key.

Portrait-oriented original

(A3 or B4 (11" x 17" or 8-1/2" x 14") size)

Before [BINDING CHANGE] After [BINDING CHANGE]

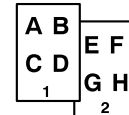
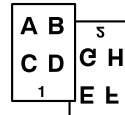

4 Touch the [OK] key.

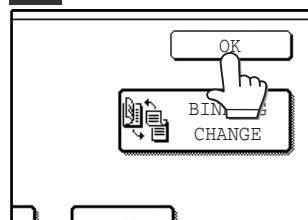

5 Make sure that a suitable paper size is automatically selected, or select another size using the [PAPER SELECT] key.

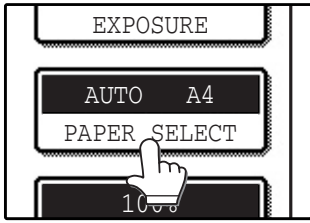

6 Select the number of copies and any other desired copy settings, and then press the [START] key (⏻).

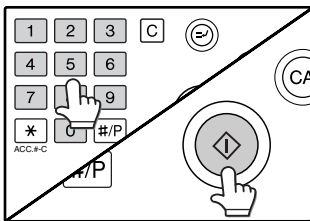

The original for the front side is scanned.

7 Remove the first original and then place the original for the back side on the document glass. Close the document cover/RSPF and then press the [START] key (⏻).

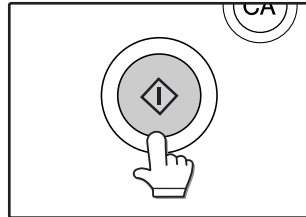

To cancel automatic two-sided copying, press the [CLEAR] key (⏻).



Note When making two-sided copies of an odd number of originals, touch the [READ-END] key after scanning the last original.

USING THE RSPF

1 Place the original(s) in the document feeder tray. (p.23)

2 Touch the [2-SIDED COPY] key.

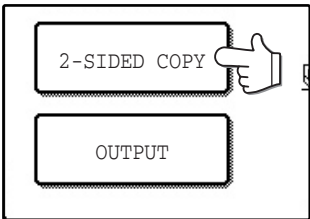

3 Touch the desired copy mode.

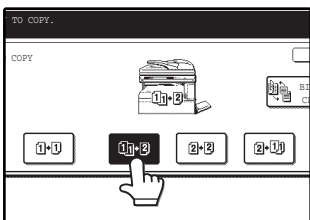

Touch the [BINDING CHANGE] key when making the tablet binding, or when making automatic two-sided copies of a one-sided A3 or B4 (11" x 17" or 8-1/2" x 14") size portrait original, touch the [BINDING CHANGE] key.

Portrait-oriented original

(A3 or B4 (11" x 17" or 8-1/2" x 14") size)

Before [BINDING CHANGE] After [BINDING CHANGE]

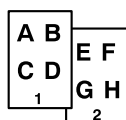
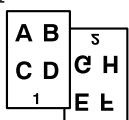

4 Touch the [OK] key.

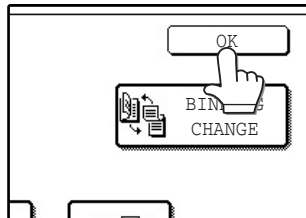

5 Make sure that a suitable paper size is automatically selected, or select another size using the [PAPER SELECT] key.

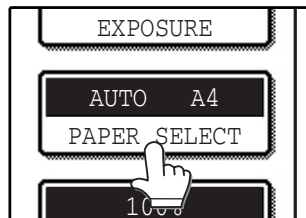

6 Select the number of copies and any other desired copy settings, and then press the [START] key (⏻).

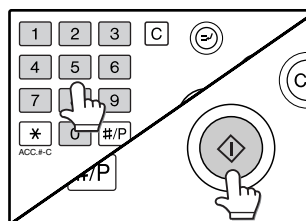

EXPOSURE ADJUSTMENT

SELECTING THE ORIGINAL IMAGE TYPE AND MANUALLY ADJUSTING THE EXPOSURE

[AUTO] is selected by default for automatic adjustment of the image according to the original. If you wish to specify the original image type or manually adjust the exposure, place the original in the RSPF or on the document glass, check the paper size, and then perform the following steps.

1 Touch the [EXPOSURE] key.

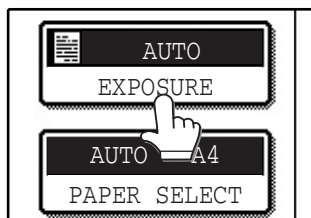

2 Select [TEXT], [TEXT/PHOTO], or [PHOTO] as appropriate for the original.

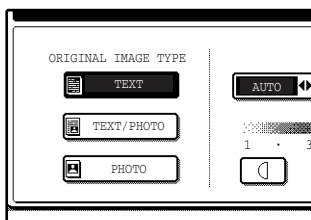

Selecting the original image type

- Four original image type selections are available.

TEXT	Use for regular text, blueprints, and light pencil writing.
TEXT/PHOTO	Use for mixed text/photo originals and printed photos.
PHOTO	Use for photos and when you desire clearer halftones.

- Automatic exposure adjustment can only be selected when [TEXT] is selected for the original image type.

3 Manually adjust the copy exposure.

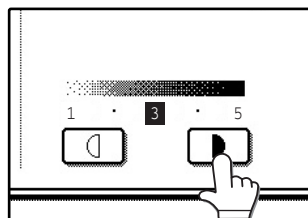

If [TEXT] was selected for the original image type, touch the [AUTO ◀▶ MANUAL] key to select [MANUAL] and then adjust the copy exposure.

Touch the key to make darker copies.
Touch the key to make lighter copies.



Exposure value guidelines

- 1 - 2 Dark originals like newspapers
- 3 Normal originals
- 4 - 5 Light coloured text or text written in pencil

To change back to automatic exposure adjustment, follow these steps:

- 1 Touch the [EXPOSURE] key.
- 2 Touch the [TEXT] key.
The [AUTO ◀▶ MANUAL] key appears when [TEXT] is selected.
- 3 Touch the [AUTO ◀▶ MANUAL] key so that [AUTO] is highlighted.
- 4 Touch the [OK] key.

4 Touch the [OK] key.

You will return to the main screen of copy mode.

5 Check the paper size, select the number of copies and any other desired copy settings, and then press the [START] key (⏻).

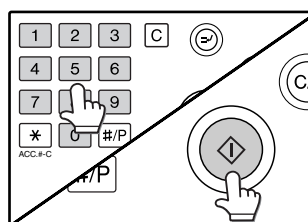

REDUCTION/ENLARGEMENT/ZOOM

There are three ways to enlarge and reduce copies:

- Automatic ratio selection according to the paper size AUTOMATIC RATIO SELECTION (below)
- Specifying a ratio with the reduce key, enlarge key, or zoom key MANUAL RATIO SELECTION (p.31)
- Separately selecting vertical and horizontal ratios XY ZOOM copying (p.32)

Ratios that can be selected vary depending on the following conditions:

Original position	Selectable ratios
Document glass	25 to 400%
RSPF	50 to 200%

AUTOMATIC RATIO SELECTION

The ratio is automatically selected based on the original size and paper size.

1 Place the original(s). (p.22, p.23)

The original size appears in the touch panel.



- If the original size does not appear in the touch panel, specify the original size manually. (p.47)
- Automatic ratio selection is not possible if the original or paper is a non-standard size.

2 Touch the [PAPER SELECT] key and then select the desired paper size.

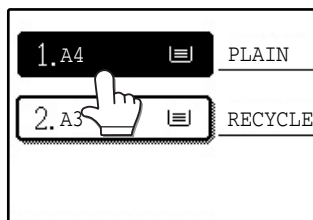

The selected key is highlighted and the paper selection screen closes.



If paper of the desired size is not loaded in any of the trays, load paper of the required size in a paper tray or in the bypass tray. (p.19)

3 Touch the [AUTO IMAGE] key.

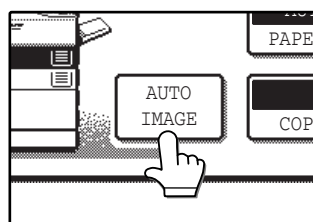

A suitable ratio is selected based on the original size and selected paper size. (The ratio appears in the touch panel.)



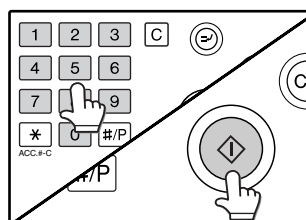

- When automatic ratio selection is selected, the [AUTO IMAGE] key is highlighted in the main screen.
- If the original and paper are in different orientations, the image is automatically rotated to match the paper orientation (for paper sizes A4 (8-1/2" x 11") or less).
- Rotation of the image can be disabled in the key operator programs. (See the "Key operator's guide".)
- If "IMAGE IS LARGER THAN THE COPY PAPER." appears in the touch panel, part of the image will be cut off in the copy.

4 Select the number of copies and any other desired settings, and then press the [START] key (⏻).



To cancel automatic ratio selection, touch the [AUTO IMAGE] key. Automatic ratio selection also turns off automatically when the enlargement key, the reduction key, or a [ZOOM] key (⏪/⏩) is touched to allow the ratio to be selected.

MANUAL RATIO SELECTION

There are five (four) preset reduction ratios and five (four) preset enlargement ratios. In addition, the [ZOOM] keys (, ) can be pressed to select the ratio in increments of 1%.

1 Place the original(s). (p.22, p.23)

2 Touch the [COPY RATIO] key.

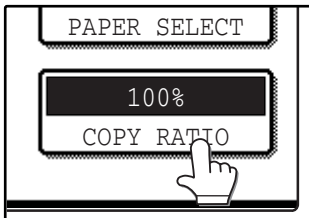

3 Use the [MENU] key to select menu [1] or menu [2] for copy ratio selection.

Menu 1

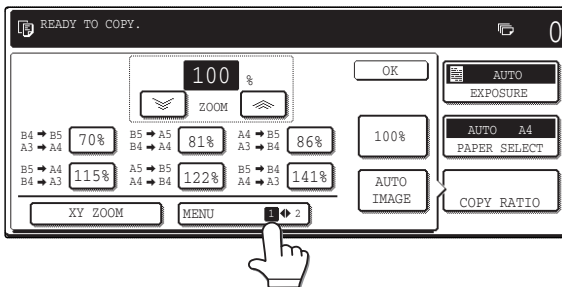

- Preset reduction keys : 70%, 81%, 86% (64%, 77%)
- Preset enlargement keys : 115%, 122%, 141% (121%, 129%)
- [100%] key 100%



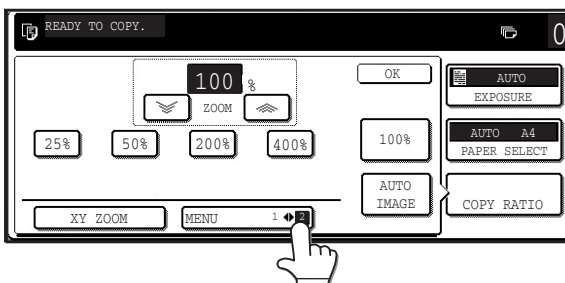



Menu 2

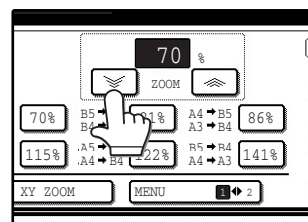
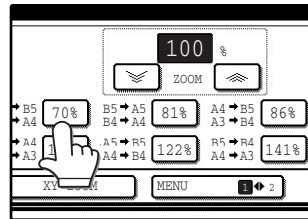



- Preset reduction keys : 25%, 50%
- Preset enlargement keys : 200%, 400%
- [100%] key 100%

4 Use the enlargement key or reduction key, or the [ZOOM] key (,) to set the desired copy ratio.



The [ZOOM] keys (, ) can be used to change the ratio in increments of 1%. Touch the  key to increase the ratio or the  key to decrease the ratio. Continuing to touch a [ZOOM] key (, ) makes the ratio change faster.



- Touch a reduction or enlargement key to set the approximate ratio, then touch the  key to decrease the ratio or the  key to increase the ratio.
- If "IMAGE IS LARGER THAN THE COPY PAPER." appears, the selected copy ratio is too large for the paper size. However, if you press the [START] key () a copy will be made.

5 Touch the [OK] key.

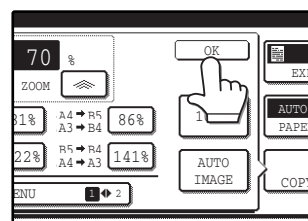

6 Make sure that a suitable paper size is automatically selected, or select another size using the [PAPER SELECT] key.

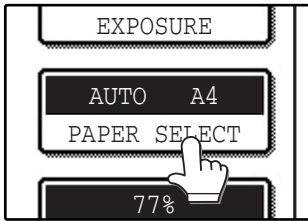

If AUTO PAPER SELECT is enabled, the appropriate copy paper size is automatically selected based on the original size and selected copy ratios.

7 Select the number of copies and any other desired copy settings, and then press the [START] key (⏻).

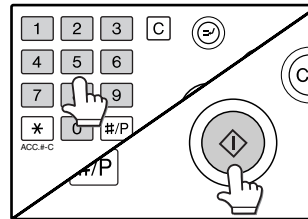

To return the ratio setting to 100%, touch the [COPY RATIO] key to display the ratio menu and then touch the [100%] key. (p.31, step 3)

SELECTING THE VERTICAL AND HORIZONTAL COPY RATIOS SEPARATELY (XY ZOOM copying)

The XY ZOOM feature allows the horizontal and vertical copy ratios to be changed independently.

Example: Vertical ratio set to 100% and horizontal ratio set to 50%.

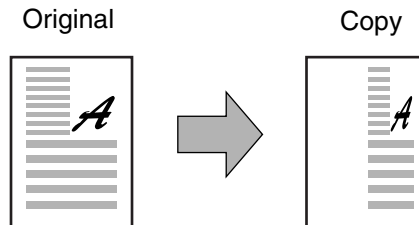

- The AUTO IMAGE/MULTI SHOT/PAMPHLET COPY feature cannot be used in combination with the XY ZOOM function.
- To use the XY ZOOM feature with the DUAL PAGE COPY feature (p.43), set the DUAL PAGE COPY feature first and then the XY ZOOM feature.

1 Place the original(s). (p.22, p.23)

2 Touch the [COPY RATIO] key.

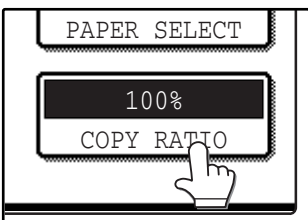

3 Touch the [XY ZOOM] key.

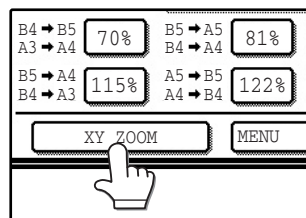

4 Touch the [X] key.

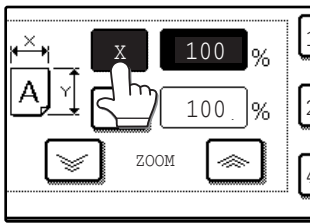

The [X] key is selected (highlighted) by default, so there is normally no need to perform this step (Go to step 5.). If the [X] key is not highlighted, perform this step.

5 Use the reduction, enlargement, and [ZOOM] keys ([] / []) to change the copy ratio in the horizontal (X) direction.

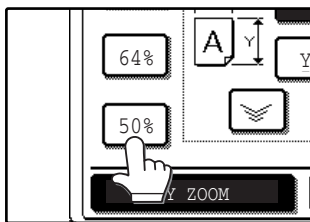

A fixed ratio key will not become highlighted when touched.

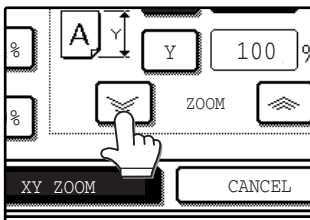

The [ZOOM] keys ([] / []) can be used to change the ratio in increments of 1%. Touch the [] key to increase the ratio, or the [] key to decrease the ratio. Continuing to touch a [ZOOM] key ([] / []) makes the ratio change faster.

Note Touch a reduction or enlargement key to set the approximate ratio, then touch the [] key to decrease the ratio or the [] key to increase the ratio.

6 Touch the [Y] key.

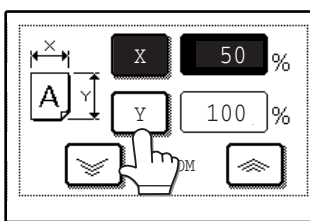

7 Use the reduction, enlargement, and [ZOOM] keys ([] / []) to change the copy ratio in the vertical (Y) direction.

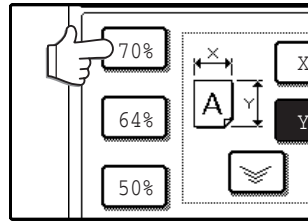

A fixed ratio key will not become highlighted when touched.

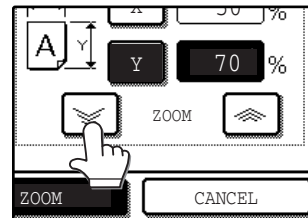

If you need to readjust the horizontal ratio, touch the [X] key again.

8 Touch the [OK] key.

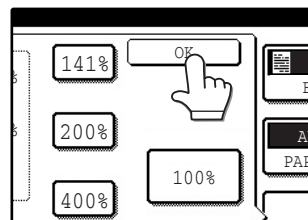

9 Make sure that a suitable paper size is automatically selected, or select another size using the [PAPER SELECT] key.

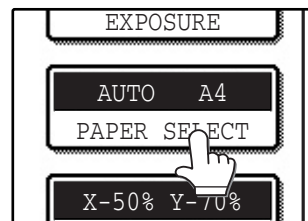

If AUTO PAPER SELECT is enabled, the appropriate copy paper size is automatically selected based on the original size and selected copy ratios.

10 Select the number of copies and any other desired copy settings, and then press the [START] key ([]).

Note To cancel this function, touch the [CANCEL] key in the XY ZOOM screen.

INTERRUPTING A COPY RUN

A copy run can be temporarily interrupted to allow another copy job to be performed. When the other job is finished, the copy run will resume using the original copy settings.



Automatic two-sided copying, sort/group copying, staple sort, pamphlet copy, mix feeding, job build, cover copy, job programs, card shot, card shot, or multi shot copying cannot be used for interrupt copying.

1 Press the [INTERRUPT] key (⊖) to interrupt the copy run.

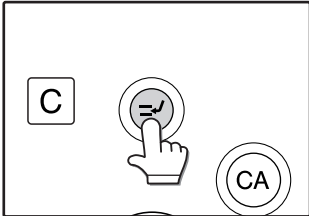

The [INTERRUPT] key (⊖) blinks until the machine is ready for the interrupt job, after which it lights steadily.

If you decide to cancel the interrupt job while selecting settings, press the [INTERRUPT] key (⊖).



- If audit mode is enabled, a message will appear prompting you to enter your account number. Enter your account number with the numeric keys. The copies that you make will be added to your account's count.
- If an original is being scanned when the [INTERRUPT] key (⊖) is pressed, the interrupt job will begin after the original is scanned. If a copy is being printed, the interrupt job will begin after the copy is printed.

2 Remove the previous original(s) and place the original(s) of the interrupt copy job. (p.22, p.23)

3 Select the number of copies and any other desired copy settings, and then press the [START] key (⊕).

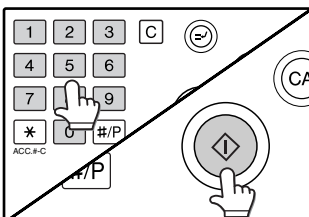

The interrupt copies will be offset from the previous copies. (Offset function, p.35)

4 When the copy job is finished, press the [INTERRUPT] key (⊖) and remove the original(s).

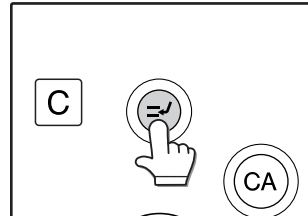

5 Replace the previous original(s) and press the [START] key (⊕) to resume copying.

Replace only the originals that have not yet been scanned.

3

Chapter 3

CONVENIENT COPY FUNCTIONS

This chapter explains special finishing functions and other convenient functions.

COPY FINISHING FUNCTIONS

This section explains the sort, group, and offset functions, as well as the staple sort function which is used to staple output collated with the sort function when a finisher is installed.

SORT COPY

This function is used to collate sets of copies. The copies are delivered to the centre tray, and to other trays when a job separator tray or finisher is installed.

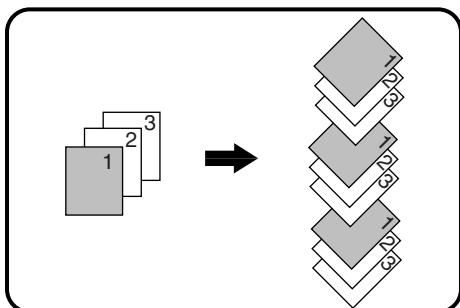

GROUP COPY

This function is used to group sets of copies by page. The copies are delivered to the centre tray, and to other trays when a job separator tray or finisher is installed.

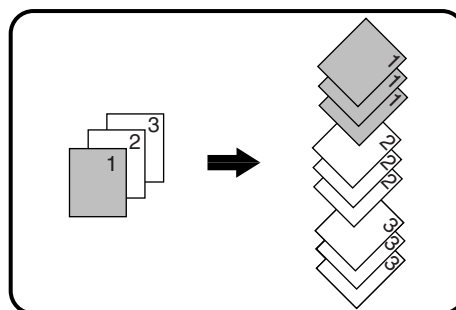

OFFSET FUNCTION

Each set of copies is offset from the previous set in the output tray, making it easy to distinguish one set from another. (The offset function can be used in the centre tray or in the offset tray of the finisher.)

Offset function "ON"

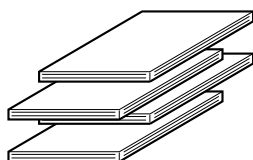

Offset function "OFF"

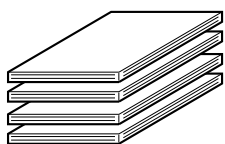

Enabling the offset function

The offset function operates when a checkmark appears in the [OFFSET] checkbox, which is displayed by touching the [OUTPUT] key. (If a checkmark does not appear, touch the checkbox.)

1 Place the originals in the RSPF or on the document glass. (p.22, p.23)

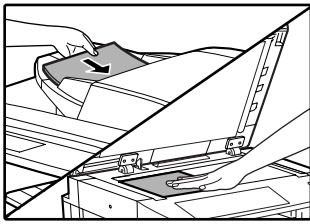

If originals are placed in the RSPF, the sort function is automatically selected. (To disable this function, see the "Key operator's guide".)

Example: 5 sets of copies or 5 copies per page of 3 originals



2 Touch the [OUTPUT] key.

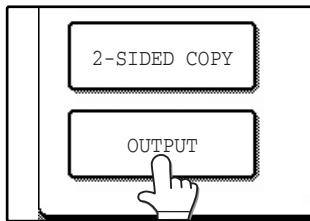

3 Touch the [SORT] or [GROUP] key.

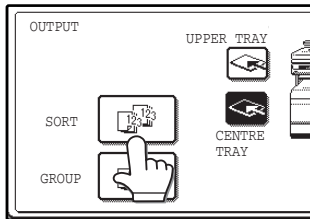

4 Touch the output tray that you wish to use.

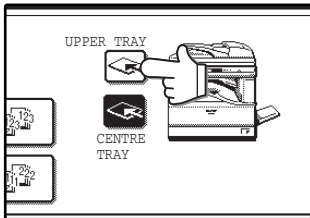

The output tray can only be selected when a job separator or finisher is installed.



To enable the offset function (p.35), touch the [OFFSET] checkbox so that a checkmark appears. To disable the offset function, touch the [OFFSET] checkbox again to clear the checkmark.

5 Touch the [OK] key.

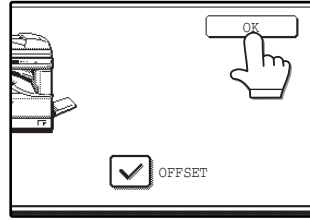

6 Select the number of copies and any other desired copy settings, and then press the [START] key (⏻).

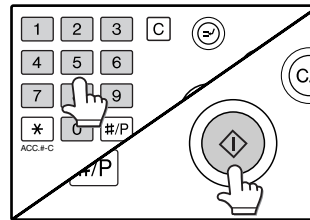

7 [When using the RSPF:]

Copying will start after all the originals are scanned.

[When using the document glass:]

Replace the original with the next original and press the [START] key (⏻). Repeat this step until all originals have been scanned, and then touch the [READ-END] key.

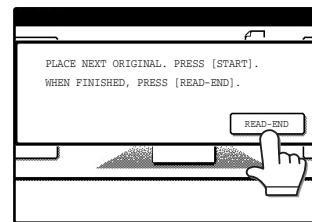

The copies are grouped as follows:

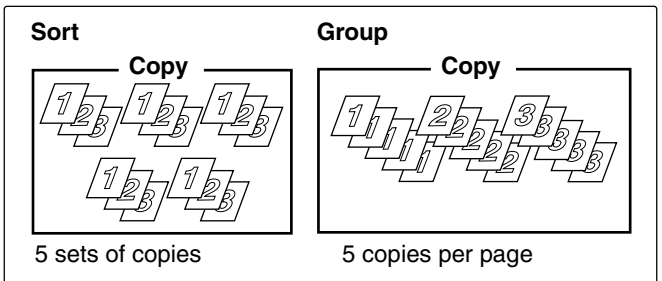

If the memory becomes full while scanning the originals, "MEMORY IS FULL. PRESS [START] TO BEGIN COPYING OR [CA] TO CANCEL." will appear. To copy only the originals that have been scanned, press the [START] key (⏻). To cancel the job, press the [CLEAR ALL] key (⊗).





The number of originals that can be scanned into memory can be increased by increasing the memory allocation in the key operator programs, or by installing more memory. (See the "Key operator's guide".)

STAPLE SORT (when the finisher (AR-FN5A) is installed)

This function collates the copies, staples each set, and delivers the sets to the offset tray. The staple sort function can only be used when a finisher is installed.

In addition to the staple sort function, other functions such as the pamphlet staple function can be used when the saddle stitch finisher (AR-F14N) is installed. For detailed information, see the manual that accompanies the saddle stitch finisher.

Stapling position	Portrait orientation		Landscape orientation	
Top left corner		Available paper sizes: A4 and B5 (8-1/2" x 11") Stapling capacity: For each size, up to 30 sheets can be stapled.		Available paper sizes: A3, B4 and A4R, (11" x 17", 8-1/2" x 14", 8-1/2" x 13", 8-1/2" x 11" R) Stapling capacity: For each size, up to 30 sheets can be stapled.

ORIENTATION OF THE ORIGINAL AND STAPLING POSITIONS

If the orientation of the originals does not match that of the copy paper, the images will be rotated. The stapling position varies with the orientation of the original.

3

Using the RSPF

Insert the originals face up.

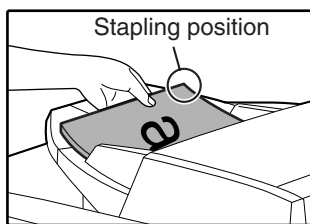

Using the document glass

Place each original face down.

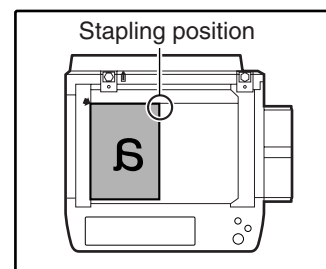

When copying B4 or A3 (8-1/2" x 14" or 11" x 17") vertically oriented originals, the copies will be stapled at the position shown below.

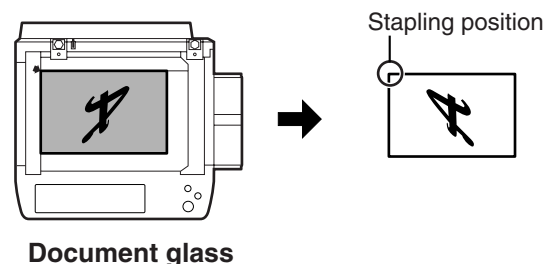
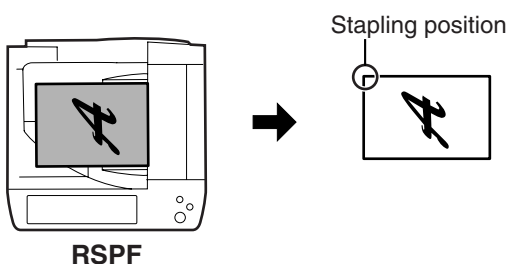

- When using letterhead paper in the staple sort, load the paper with the letterhead to the front or to the right as shown in the diagram.

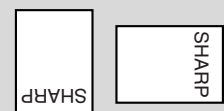

- Different sized originals cannot be copied on the corresponding sizes of paper.
- The staple sort function cannot be used if disabled in the key operator programs. (See the "Key operator's guide".)
- The offset function (p.35) cannot be used.

1 Place the original(s). (p.22, p.23)

2 Touch the [OUTPUT] key.

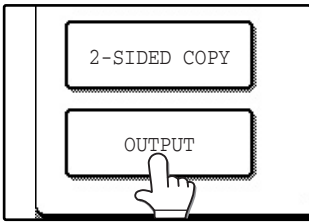

3 Touch the [STAPLE SORT] key.

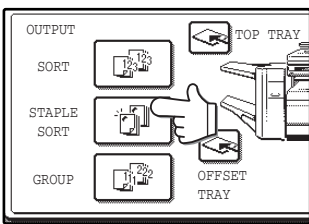

When the [STAPLE SORT] key is selected, the offset tray is automatically selected as the output tray. The top tray and centre tray cannot be used.

4 Touch the [OK] key.

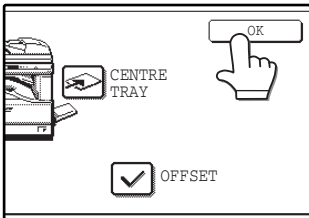

5 Select the number of copies and other copy settings, and then press the [START] key (Ⓢ).

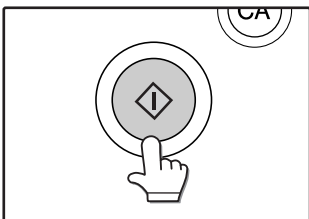

6 [When using the RSPF:]

Copying will start after all originals have been scanned.

[When using the document glass:]

Replace the original with the next original and press the [START] key (Ⓢ). Repeat this step until all originals have been scanned, and then touch the [READ-END] key.

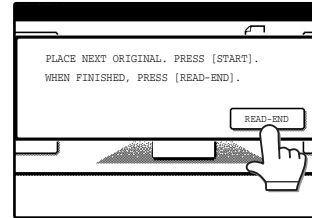

If the memory becomes full while scanning the originals, "MEMORY IS FULL. PRESS [START] TO BEGIN COPYING OR [CA] TO CANCEL." will appear. To copy only the originals that have been scanned, press the [START] key (Ⓢ). To cancel the job, press the [CLEAR ALL] key (ⓐ).



Note The number of originals that can be scanned into memory can be increased by increasing the memory allocation in the key operator programs, or by installing more memory. (See the "Key operator's guide".)

SPECIAL MODES

When the [SPECIAL MODES] key in the main screen of copy mode is touched, the special modes screen will appear. This screen contains the following special function keys.

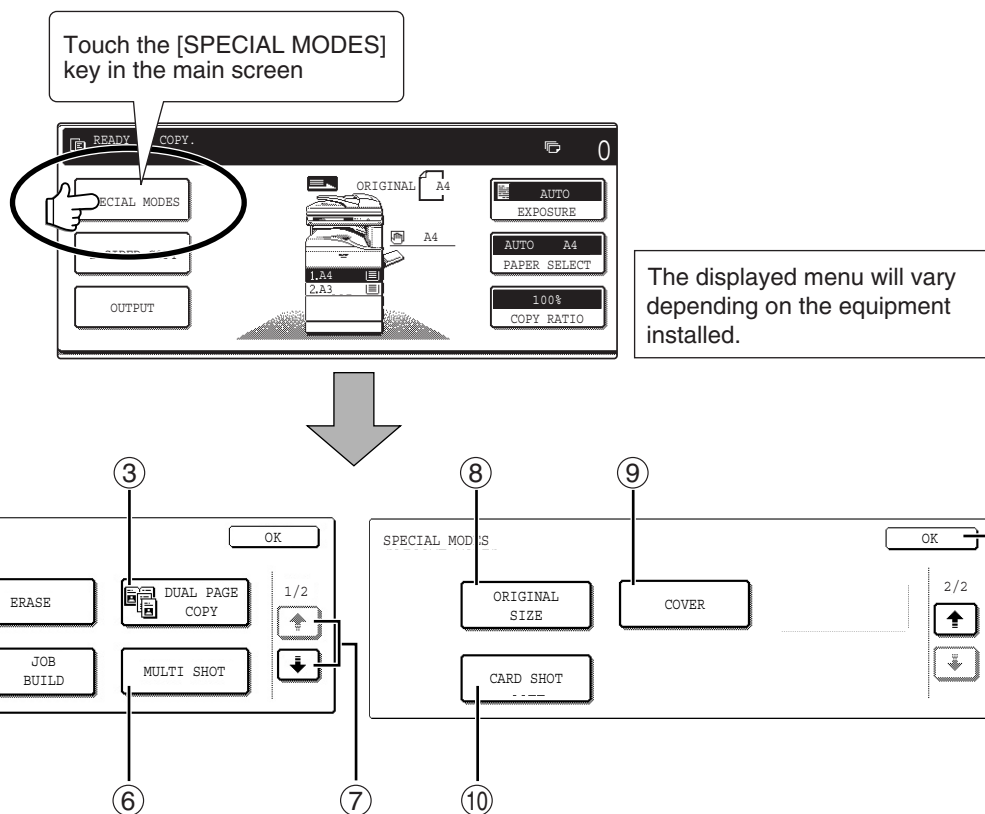

① **[MARGIN SHIFT] key (p.41)**

Use this to shift the image on the copy paper to create binding margins.

② **[ERASE] key (p.42)**

Use this to erase peripheral shadows that occur when making copies of books and other thick originals.

③ **[DUAL PAGE COPY] key (p.43)**

Use this to make separate copies of the left and right pages of bound documents.

④ **[PAMPHLET COPY] key (p.44)**

The pamphlet copy function is used to arrange copies in the proper order for centre-stapling and folding into a booklet. Two original pages are copied onto each side of the paper, such that a total of four pages are copied onto one sheet.

⑤ **[JOB BUILD] key (p.45)**

Use this when you need to copy more originals than can be placed in the RSPF at once. This allows you to divide the originals into sets and scan them sequentially in the RSPF.

⑥ **[MULTI SHOT] key (p.46)**

The multi shot copy function is used to copy two or four originals onto one sheet of copy paper in any of four layout patterns.

⑦ **(↓) key, (↑) key**

Use these to change pages in the special functions screen.

⑧ **[ORIGINAL SIZE] key (p.47)**

Use to manually select the original size. When the original size is selected, the auto ratio select function will automatically select an appropriate ratio based on the paper size.

⑨ **[COVER] key (p.48)**

Press this to use a different type of paper for front and back covers (When the RSPF is used.).

⑩ **[CARD SHOT] key (p.50)**

The front and reverse sides of a card can be copied onto one sheet of paper.

⑪ **[OK] key**

Touch to return to the main screen of the copy mode.



Note Some functions cannot be used in combination with each other. If a prohibited combination of functions has been selected, a message will appear in the touch panel.

GENERAL PROCEDURE FOR USING THE SPECIAL FUNCTIONS

1 Touch the [SPECIAL MODES] key.

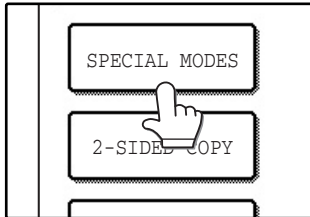

2 Touch the key of the desired special mode.

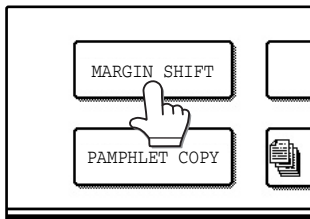

Example:
Selecting the margin shift
function

Procedures for modes that require further settings are explained starting on the next page.

MARGIN SHIFT COPY

The margin shift function is used to automatically shift the text or image on the copy paper approximately 10 mm (1/2") in its initial setting.

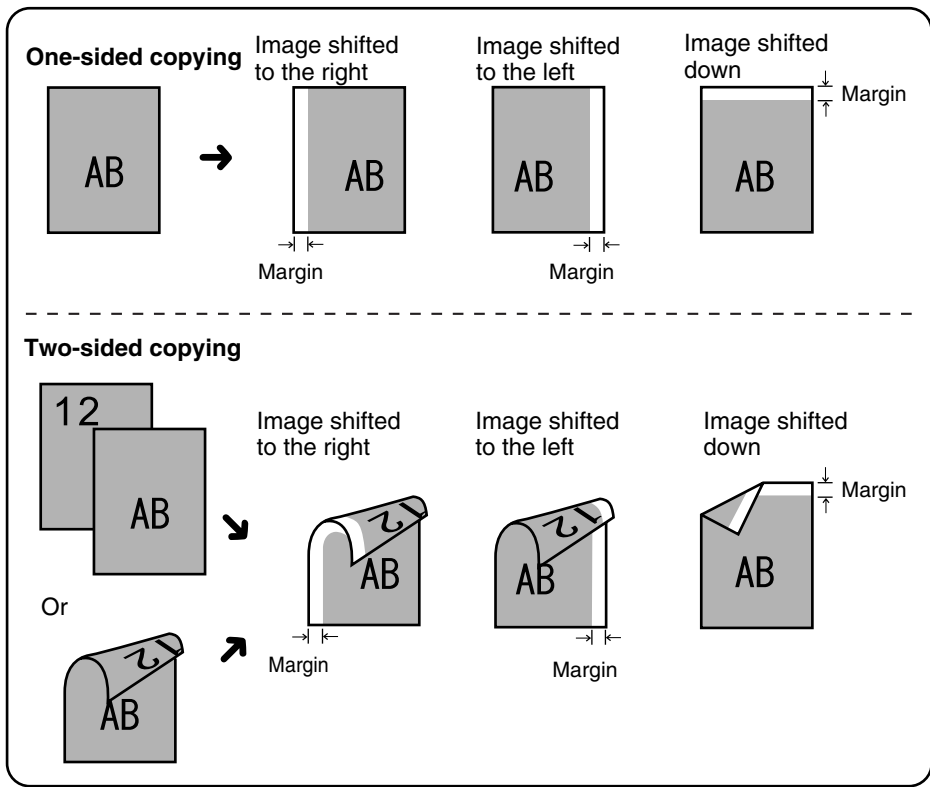

- Right, left or down can be selected for the shift direction as shown in the illustration.
- The shift width (margin) can be set from 0 mm to 20 mm increments of 1 mm (0" to 1" in increments of 1/8").
- If [DOWN] key is selected, set the original(s) so that the margin to be increased is set to the rear side of the RSPF or the document glass.

3

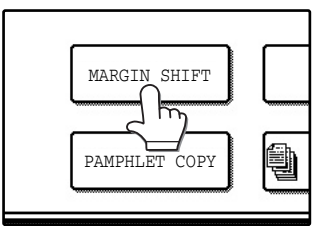

1 Touch the [MARGIN SHIFT] key in the special modes screen.

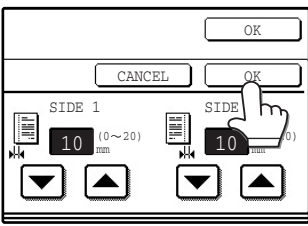

The margin shift setting screen will appear. The margin shift icon (, etc.) will also appear in the screen to indicate that the function is turned on.

3 Adjust the shift width as needed and touch the [OK] key.



Use the  and  keys to set the shift width. The shift width can be set from 0 mm to 20 mm increments of 1 mm (0" to 1" in increments of 1/8").

2 Select the shift direction.

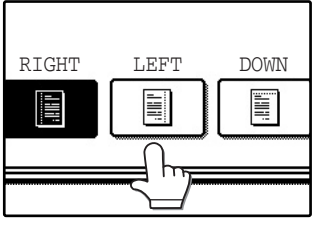

Touch the [RIGHT], [LEFT], or [DOWN] key. The selected key will be highlighted.

4 Touch the [OK] key in the special modes screen.

You will return to the main screen of copy mode.

About the steps that follow
 If you are using the document glass, see page 22.
 If you are using the RSPF, see page 23.

- Note**
- When margin shift is selected, rotation copying will not function.
 - This feature cannot be used with paper that is not a standard size.
 - To cancel the margin shift function, touch the [CANCEL] key in the margin shift setting screen. (See the screen of step 3.)

ERASE COPY

The erase function is used to erase the shadow lines on copies that are produced when copying thick originals or books. The erase modes that can be selected are shown below. The erase width is initially set to 10 mm (1/2").

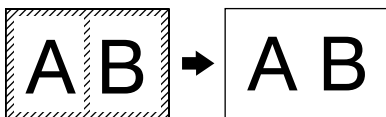
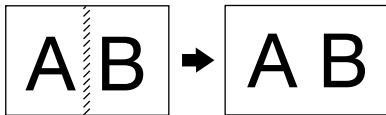
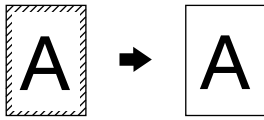

EDGE ERASE

Eliminates shadow lines around the edges of copies caused when heavy paper or a book is copied.

CENTRE ERASE

Eliminates shadow lines produced by the bindings of bound documents.

EDGE + CENTRE ERASE

Eliminates both the shadow lines around the edges of copies and the shadow at the centre.

1 Touch the [ERASE] key in the special modes screen.

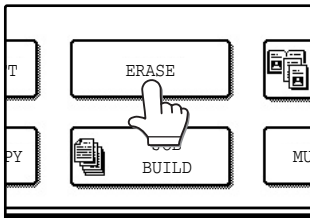

The erase setting screen will appear. The erase icon (, etc.) will also appear in the screen to indicate that the function is turned on.

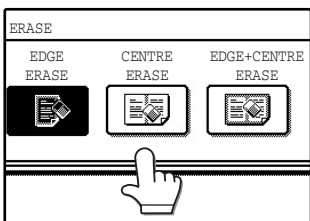

2 Select the desired erase mode.

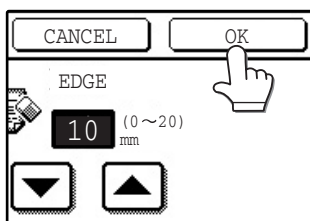

Select one of the three erase modes. The selected key will be highlighted.

3 Adjust the erase width as needed and touch the [OK] key.



Use the  and  keys to adjust the erase width. The erase width can be set from 0 mm to 20 mm increments of 1 mm (0" to 1" in increments of 1/8").

4 Touch the [OK] key in the special modes screen.

You will return to the main screen of copy mode.

About the steps that follow

If the document glass is being used, see page 22.
If the RSPF is being used, see page 23.



- This feature cannot be used with non-standard size originals.
- This feature cannot be selected when mixed feeding (p.25) is used.
- To cancel the erase copy function, touch the [CANCEL] key in the erase setting screen. (See the screen of step 3.)

DUAL PAGE COPY

The dual page copy function produces separate copies of two adjoining pages on the document glass. It is especially useful when copying books and other bound documents.

[Example] Copying the right and left pages of a book

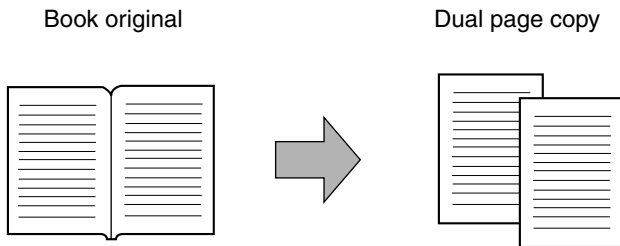

- A reduction setting can be selected when using the dual page copy function, however, an enlargement setting cannot be selected.
- The dual page copy function can only be used when copying from the document glass. The RSPF cannot be used.
- B5 or A4 (8-1/2" x 11") paper can be used.

1 Touch the [DUAL PAGE COPY] key in the special modes screen.

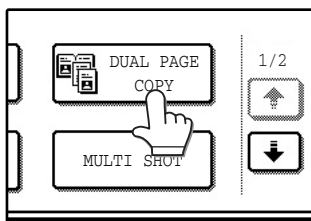

The [DUAL PAGE COPY] key is highlighted to indicate that the function is enabled, and the dual page copy icon (📄📄) will appear in the screen.

2 Touch the [OK] key in the special modes screen.

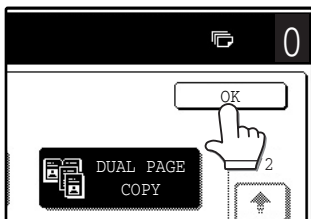

You will return to the main screen of copy mode.

3 Place the originals on the document glass. (p.22)

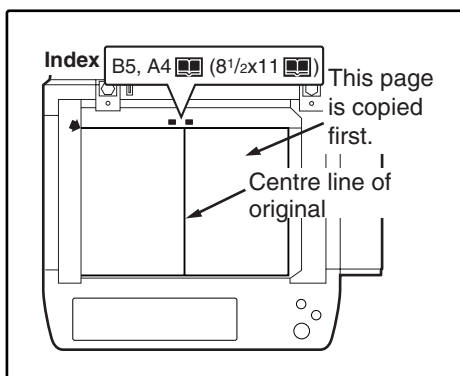

When copying book originals:

When copying a thick book, press down gently on the book to flatten it against the document glass.

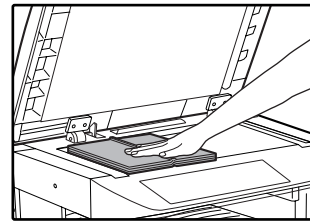

4 Make sure that B5 or A4 (8-1/2" x 11") size paper is selected.

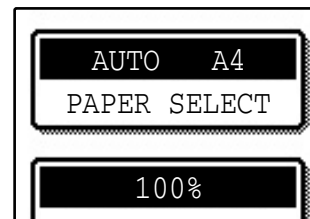

If B5 or A4 (8-1/2" x 11") size paper is not selected, touch the [PAPER SELECT] key to select B5 or A4 (8-1/2" x 11") paper.

5 Select the number of copies and any other desired copy settings, and then press the [START] key (⏻).

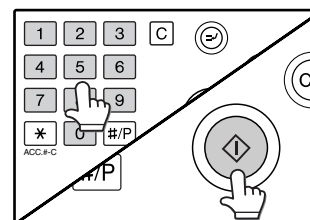

Note

- To cancel the dual page copy function, touch the [DUAL PAGE COPY] key in the special modes screen. (The key will no longer be highlighted.) (See the screen of step 1.)
- To erase shadows caused by the document binding, use the edge erase function (p.42). (Centre Erase and Edge + Centre Erase cannot be used with the dual page copy function.)

3

PAMPHLET COPY

The pamphlet copy function is used to arrange copies in the proper order for centre-stapling and folding into a booklet. Two original pages are copied onto each side of the copy paper, such that a total of four pages are copied onto each sheet.

This function is convenient for arranging copies into an attractive booklet or pamphlet.

[Example]: Copying 8 originals with pamphlet copy

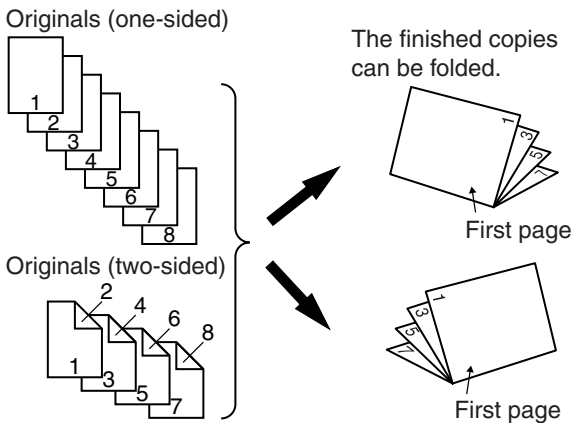

- Scan the originals in order from the first page to the last page. The order of copying will be automatically adjusted by the machine.
- Either left binding (opening from right to left) or right binding (opening from left to right) can be selected.
- Four originals will be copied onto one sheet. Blank pages may be automatically added at the end, depending on the number of the originals.

1 Touch the [PAMPHLET COPY] key in the special modes menu screen.

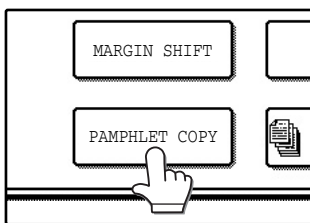

The pamphlet copy setting screen will appear. The pamphlet copy icon (📄, etc.) will also appear in the upper left corner of the screen to indicate that the function is enabled.

2 Specify whether 1-sided or 2-sided originals will be copied.

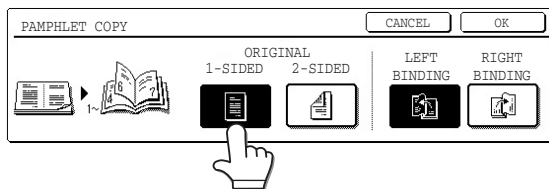

3 Select the binding position ([LEFT BINDING] or [RIGHT BINDING]) and then touch the [OK] key in the pamphlet copy setting screen.

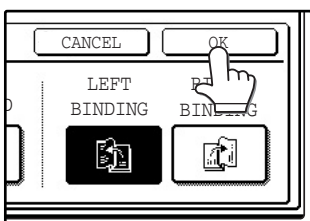

You will return to the special modes menu screen.

4 Touch the [OK] key in the special modes screen.

You will return to the main screen of copy mode.

5 Place the original(s). (p.22, p.23)

6 Make sure that a suitable paper size has been automatically selected.

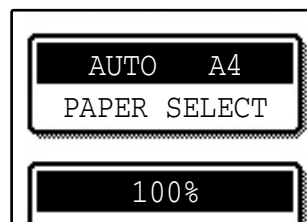

If the desired copy paper size is not selected, use the [PAPER SELECT] key to select the paper size. After the paper size is selected, touch the [AUTO IMAGE] key. A suitable ratio will be automatically selected.

7 Select the number of copies and any other desired copy settings, and then press the [START] key (⏻).

8 [When using the RSPF:]

Copying will start after all originals have been scanned.

[When using the document glass:]

Replace the original with the next original and press the [START] key (⏻). Repeat this step until all originals have been scanned, and then touch the [READ-END] key.

When the pamphlet copy function is selected, two-sided copying will be automatically enabled.

Note To cancel the pamphlet copy function, touch the [CANCEL] key in the pamphlet copy setting screen. (See the screen of step 2.)

JOB BUILD MODE

Use this function when you need to copy more originals than can be placed in the RSPF at once. (The maximum number of originals that can be placed in the RSPF at once is 100.)



- If the memory becomes full while scanning the originals, "MEMORY IS FULL. PRESS [START] TO BEGIN COPYING OR [CA] TO CANCEL." will appear. To copy only the originals that have been scanned, press the [START] key (Ⓢ). To cancel the job, press the [CLEAR ALL] key (ⓐ).
- Depending on the content of the originals, the memory may become full before 100 originals have been scanned. In this case, press the [START] key (Ⓢ) to copy the originals that have been scanned, and then place the originals that weren't scanned in the RSPF once again and repeat the copy procedure.
- To increase the number of originals that can be scanned, install more memory or increase the memory allocation in the key operator programs. (See the "Key operator's guide".)

Example: Copying 130 sheets (A4 (8-1/2" x 11") size originals)

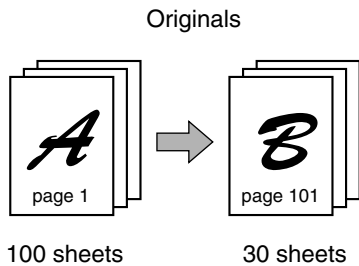

* Divide the originals into sets so that each set is no more than 100 pages. Scan the sets in order beginning from the first page of set A.

1 Touch the [JOB BUILD] key in the special modes menu screen.

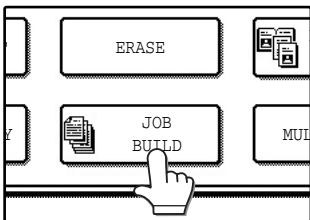

The [JOB BUILD] key is highlighted. The job build copy icon (📄) will also appear in the screen to indicate that the function is enabled.

2 Touch the [OK] key in the special modes screen.

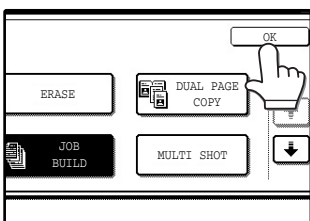

You will return to the main screen of copy mode.

3 Place the original(s) in the RSPF. (p.23)

4 Make sure that a suitable paper size is selected, select the number of copies and any other desired copy settings, and then press the [START] key (Ⓢ).

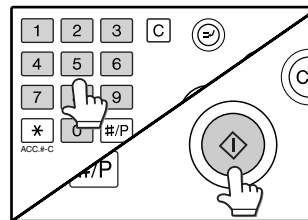

Scanning begins. When scanning of the first set of originals (A in the above example) is finished, insert the second set and press the [START] key (Ⓢ).

Repeat this step until all the remaining originals (B in the above example) have been scanned. Remove each scanned set of originals before inserting the next set.

5 Touch the [READ-END] key.

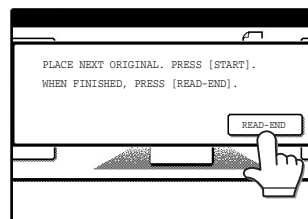

Copying begins.



To cancel the job build mode function, touch the [JOB BUILD] key in the special modes screen so that it is no longer highlighted. (See the screen of step 1.)

MULTI SHOT COPY

The multi shot copy function is used to copy two or four originals onto one sheet of copy paper in a specified order.

Example: Copying four originals onto one sheet of paper
(Page number: 4 in 1 (1/2 3/4)), layout: (1/2 3/4))

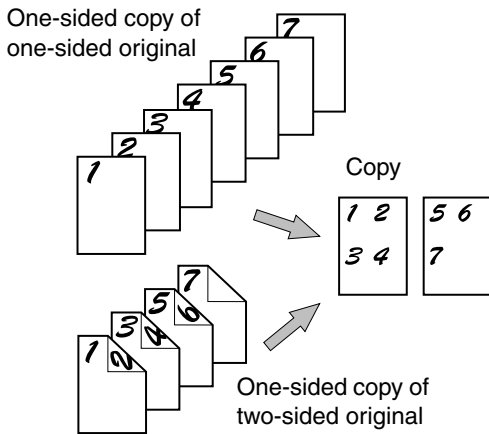

- When using the multi shot copy function, place the originals, select the desired paper size, and select the copy mode before selecting the multi shot copy function in the special modes screen.
- When using the multi shot copy function, the appropriate copy ratio will be automatically set based on the original size, paper size, and the number of originals to be copied onto one sheet. The minimum reduction ratio is 25%. (The minimum ratio is 50% when the RSPF is used.) Depending on the original size, paper size, and the number of originals to be copied onto one sheet, portions of original images may be cut off.

1 Touch the [MULTI SHOT] key in the SPECIAL MODES menu screen.

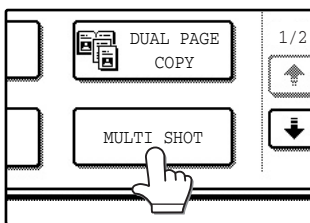

The multi shot copy setting screen will appear. The multi shot copy icon (1/2 3/4, etc.) will also appear in the screen to indicate that the function is enabled.

2 Select the number of originals to be copied onto one sheet in the multi shot copy selection screen.

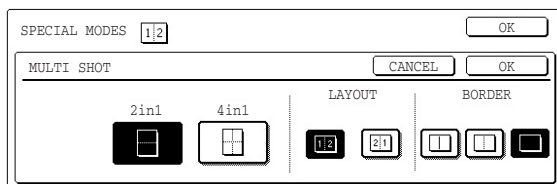

4 Select a borderline setting.

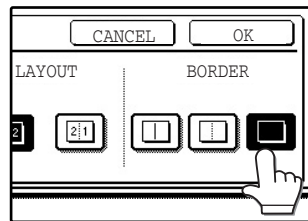

Select [1/2], [2/1], or [1/1].

5 Touch the [OK] key in the multi shot setting screen.

You will return to the special modes menu screen.

6 Touch the [OK] key in the special modes menu screen.

You will return to the main screen of copy mode.

3 Select the layout.

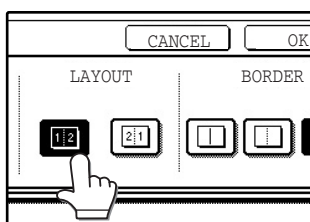

Select the order in which the originals will appear on the copy.

7 Select the number of copies and any other desired copy settings, and then press the [START] key (⏻).

8 [When using the RSPF:]

Copying will start after all originals have been scanned.

[When using the document glass:]

Replace the original with the next original and press the [START] key (⏻). Repeat this step until all originals have been scanned, and then touch the [READ-END] key if necessary.



- The images may be rotated depending on the number of originals and the orientation of the originals and copy paper.
- To cancel the multi shot copy function, touch the [CANCEL] key in the multi shot setting screen (the screen of step 2).

ORIGINAL SIZE

If you wish to use the paper other than the automatically selected original size, original size setting is specified by the special modes. The mix feeding setting (p.25) is also selected here.

1 Touch the **[+]** key and then touch the **[ORIGINAL SIZE]** key in the special modes menu screen.

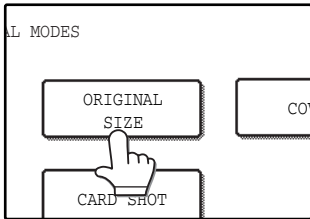

The original size setting screen will appear.

5 Touch the **[OK]** key in the special modes menu screen.

You will return to the main screen of the copy mode.



To select mixed feeding, select the "MIX SIZE ORIGINAL FEEDING MODE" checkbox. Mixed feeding is explained on page 25.

2 Touch the **[MANUAL]** key.

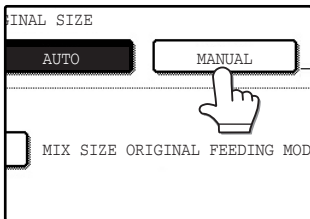

3 Select the original size.

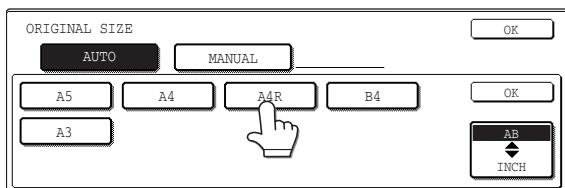

[MANUAL] key is highlighted and the selected paper size is displayed.



To select an inch size original, touch the [AB ◀▶ INCH] key. Inch sizes will appear.

4 Touch the inside **[OK]** key.

You will return to the special modes menu screen.

3

COVER COPY

Cover copy mode is used to add a cover to the front or back, or both the front and back, of a multipage document. To use cover copy mode, the RSPF must be used.

Copying onto a cover

One-sided copies from one-sided or two-sided originals

One-sided originals → One-sided copies (copying onto a cover)
 Cover original (SHARP) → Front cover (can copy onto front side) and Back cover (no copying)

Two-sided originals → One-sided copies (copying onto a cover)
 Cover original (SHARP) → Front cover (can copy onto front side) and Back cover (no copying)

Two-sided copies from one-sided or two-sided originals

One-sided originals → Two-sided copies (copying onto a cover)
 Cover original (SHARP) → Front cover (can copy onto front side) and Back cover (no copying)

Two-sided originals → Two-sided copies (copying onto a cover)
 Cover original (SHARP) → Front cover (can copy onto front side) and Back cover (no copying)

- A front cover, back cover, or both a front and a back cover can be selected.
- You can specify whether or not the front cover is copied on.
- Copying is not possible on either side of a back cover.

Not copying onto a cover

One-sided copies from one-sided or two-sided originals

One-sided originals → One-sided copies (not copying onto a cover)
 → Back cover

Two-sided originals → One-sided copies (not copying onto a cover)
 → Front cover

Two-sided copies from one-sided or two-sided originals

One-sided originals → One-sided copies (not copying onto a cover)
 → Back cover

Two-sided originals → One-sided copies (not copying onto a cover)
 → Front cover

- A front cover, back cover, or both a front and a back cover can be selected.

1 Touch the  key and then touch the [COVER] key in the special modes menu screen.

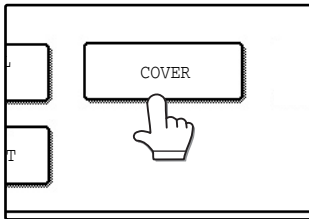

The cover setting screen will appear. The cover icon (, etc.) will also appear in the screen to indicate that the function is turned on.

2 Select the cover(s) that you wish to add.

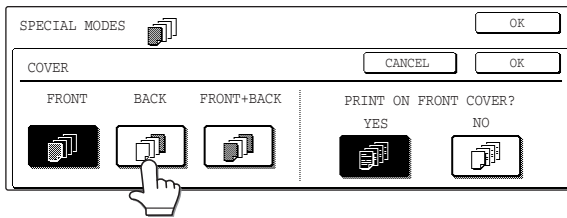

To add only a front cover, touch the [FRONT] key. To add only a back cover, touch the [BACK] key. To add both a front and back cover, touch the [FRONT+BACK] key.

3 Specify whether or not the front cover is to be copied on.

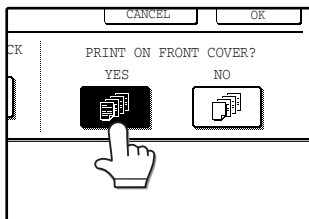

Select [YES] or [NO] in the touch panel. If [YES] is selected, the first page of the document will be copied onto the front cover sheet.

4 Touch the [OK] key in the cover setting screen.

Return to the special modes screen.

5 Touch the [OK] key in the special modes screen.

You will return to the main screen of copy mode.

6 Load the cover paper to be used into the bypass tray.

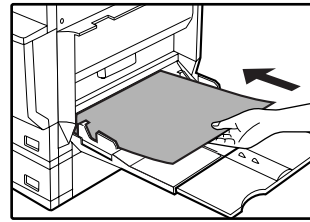

Load the same size of paper as the paper to be used for the copy job.

About the steps that follow
See page 23.

 **Note**

- It is not possible to copy on the inside of a front cover, nor on either side of a back cover.
- Be sure to place the originals in the RSPF. The document glass cannot be used for this function.
- During cover copying, stream feeding mode will not function even if enabled in the key operator programs. (See the "Key operator's guide".)
- To cancel the cover copy function, select the cover copy function again and touch the [CANCEL] key. (See the screen of step 2.)

3

CARD SHOT

The front and back of a card can be copied onto one sheet of paper. This function is convenient for making copies for certification purposes and helps save paper.

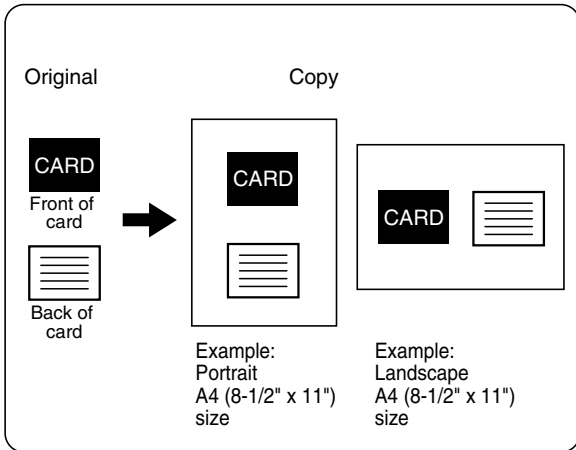

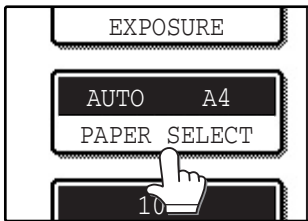

- Copying is only possible on standard size paper.
- The image cannot be rotated when using this function.

1 Make sure that a suitable paper size is selected, or select another size using the [PAPER SELECT] key.



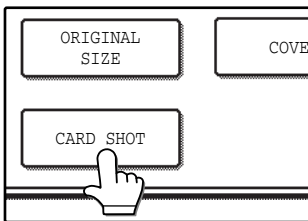

2 Touch the  key and then touch the [CARD SHOT] key in the special modes screen.

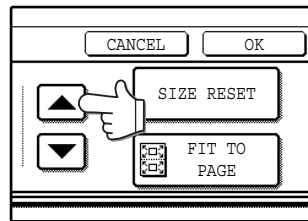

The CARD SHOT setting screen will appear. A card shot icon () will also appear in the upper left corner of the screen to indicate that the function is turned on.

3 Enter the X dimension (width) and Y dimension (length) of the original card with the   keys.



- X (width) is initially selected. Enter X dimension and then touch the Y () key to enter Y dimension.
- To change the X or Y value back to the default value, touch the [SIZE RESET] key. The default values can be changed in the key operator programs. (See the "Key operator's guide".)
- To have the images enlarged or reduced by a suitable ratio based on the entered original size so that the front and back sides fit into the selected paper size, touch the [FIT TO PAGE] key.

4 Touch the outer [OK] key.

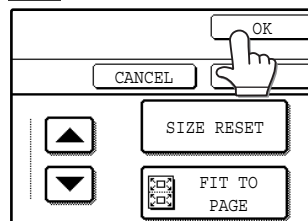

You will return to the main screen of copy mode.

5 Place the original on the document glass.

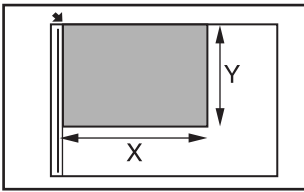

Place the front side of the original face down and close the document cover/RSPF.

6 Select the number of copies and any other desired copy settings, and then press the [START] key (⏏).

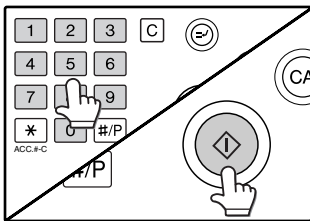

The front side of the card is scanned.

7 Place the back side of the original face down on the document glass.

8 Press the [START] key (⏏).

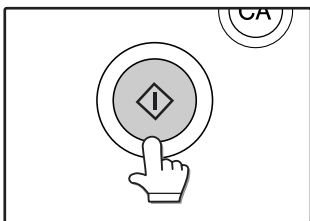

The back side of the card is scanned and copying begins.

Note

- The original must be placed on the document glass. The RSPF cannot be used.
- Even when [FIT TO PAGE] is selected, you can touch the [COPY RATIO] key in the main screen of copy mode to manually select the ratio.
- To cancel the card shot function, touch the [CANCEL] key in the card shot setting screen (the screen of step 4).

CUSTOM SETTINGS

The custom settings let you adjust certain features of the machine to better suit your needs. The custom settings include the following settings:

- TOTAL COUNT This displays the number of pages output by the machine. (p.54)
- DISPLAY CONTRAST This is used to adjust the contrast of the touch panel. (p.54)
- LIST PRINT*1 This is used to print a setting list or a font list. (p.54)
- CLOCK..... This is used to set the date and time of the machine's built-in clock. (p.54)
- TRAY SETTINGS..... This is used to configure the paper type and paper size settings for each tray, and select whether or not automatic switch over to another tray with the same size and type of paper will take place if the paper runs out during continuous printing. (p.54)

The following settings are explained in detail in the operation manual for facsimile.

- ADDRESS CONTROL*2 If your machine has the fax option, this setting is used to store fax numbers for automatic dialling. Group keys and user indexes can also be programmed.
- RECEIVE MODE*2..... This is used to select the fax receive mode (automatic or manual).
- FAX DATA FORWARD*2 This is used to forward faxes received in memory to another destination.
- KEYBOARD SELECT*3 When using the fax or network scanner function, use this setting to change the layout of the keyboard in the letter entry screen. (p.54)
- KEY OPERATOR PROGRAMS .. Settings for key operators (administrators of this machine). A key appears for these settings in the custom settings menu screen. For explanations of the settings, see the Key operator's guide. (For explanations of key operator programs for the fax option, see the operation manual for facsimile.)

*1 The fax option or network printer function must be installed.

*2 The fax option must be installed.

*3 The fax option or network scanner function must be installed.

GENERAL PROCEDURE FOR CUSTOM SETTINGS

1 Press the [CUSTOM SETTINGS] key.

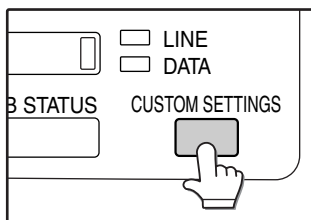

2 Touch the key of the desired setting. The setting screen will appear.

Each of the custom settings is explained on the following pages. The [TRAY SETTINGS] key is selected in the following example.

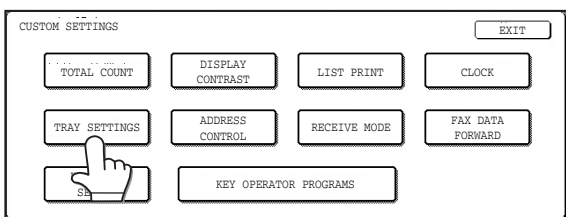

When the [TRAY SETTINGS] key is selected, the following screen appears.

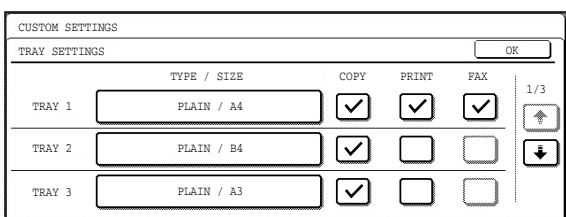

- When a checkbox appears next to an item in a screen, touch the checkbox () to select the item. A checkmark () will appear to indicate that the item is selected. In the above settings, tray 1 can be used for printer, copy, and fax mode. Tray 2 and tray 3 can only be used for copy mode.
- For a detailed explanation of the trays, see "CHANGING A TRAY'S PAPER TYPE AND PAPER SIZE SETTINGS" (p.19).

3 Touch the [OK] key in the setting screen to close it.

4 When you are ready to exit the custom settings, touch the [EXIT] key.

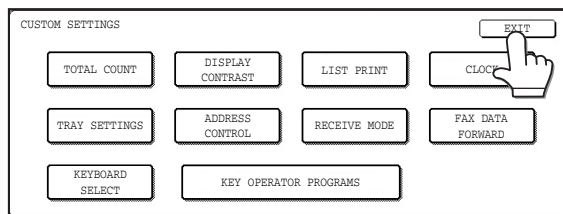

SETTINGS

Total count

The total page count display shows the following counts:

- The total count shows the combined output total of the copy, fax, and printer functions.
- Total number of copies and printed pages
- Number of pages fed through the RSPF
- Number of two-sided copies
- Number of times the stapler was used
- Number of pages sent using the network scanner function
- Number of sent and received fax pages

The counts that appear will vary depending on the peripheral equipment installed.

- Each sheet of paper that is A3 (11" x 17") size is counted as two sheets.
- Each sheet of paper used for automatic two-sided copying is counted as two sheets (A3 (11" x 17") paper is counted as four sheets.).

Display contrast

Screen contrast adjustment is used to make the touch panel easier to view under various lighting conditions. Touch the [LIGHTER] key to make the screen lighter, or the [DARKER] key to make the screen darker.

List print

Use this to print the PRINTER TEST PAGE, the FAX REPORT, or the SENDING ADDRESS LIST.

Clock

Use this to set the date and time of the machine's built-in clock. The date and time are used for functions that require date and time information.

Tray settings

The paper type, paper size, and enabled modes can be set for each tray. Auto tray switching and disabling of two-sided printing on letterhead paper can also be set. See page 19 and 20 for details on setting the paper type and paper size.

- To select which trays can be used in each of copy, printer, and fax modes, select the checkboxes (☑) of the desired trays in each mode.
- When a tray runs out of paper in the middle of a job, the auto tray switching function automatically switches the paper source to another tray that has the same paper size and paper type settings. (The auto tray switching function cannot be set for the bypass tray.)

Keyboard select

When using the fax or network scanner function, you can change the layout of the keyboard that appears in the letter entry screen. Select the layout that you find easiest to use.

The following three keyboard configurations are available:

- Keyboard 1 (QWERTY configuration)*
- Keyboard 2 (AZERTY configuration)
- Keyboard 3 (ABCDEF configuration)

*The default setting is "Keyboard 1".

(Example: Letter entry screen when Keyboard 3 is selected.)

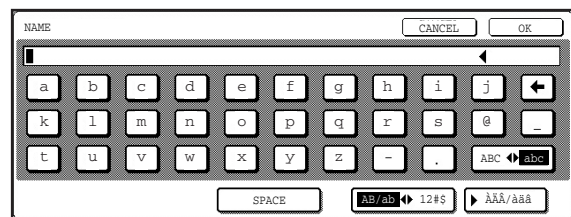

JOB PROGRAM MEMORY

If you frequently use the same settings for copy jobs, you can store in the settings in a job program. Up to 10 job programs can be stored, and the programs are retained even when the power is turned off. By storing frequently used copy settings in a program, you can eliminate the bother of selecting the settings each time you use them for a copy job.

- After a job program is stored, if any settings of the key operator programs related to the stored job program are prohibited, the related settings in the job program will not be recalled.
- If the overwriting of job programs is prohibited in the key operator programs, it will not be possible to overwrite or delete a job program.
- To exit job program memory mode, press the [CLEAR ALL] key (Ⓢ) on the operation panel or touch the [EXIT] key on the touch panel.

STORING A JOB PROGRAM

1 Press the [#P] key.

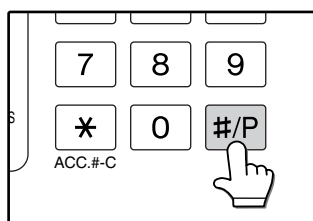

2 Touch the [STORE/DELETE] key.

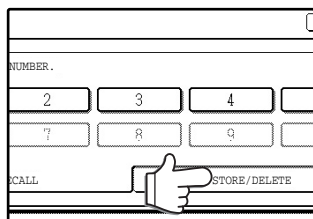

3 Touch a program number from 1 to 10 in the storage register screen.

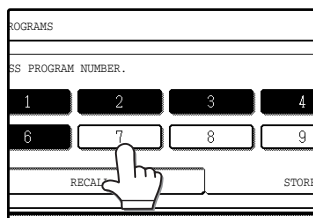

If a numeric key is selected that has already been programmed, a confirmation screen will appear. To replace the existing program with the new program, touch the [STORE] key and continue from step 4. If you do not wish to replace the existing program, touch the [CANCEL] key to return to the above screen and select a different numeric key.

4 Select the copy settings that you wish to store in the program.

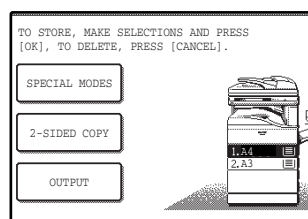

The number of copies cannot be stored.

5 Touch the [OK] key.

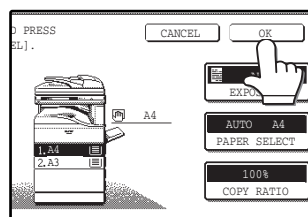

The selected settings will be stored under the program number selected in step 3.

4

EXECUTING A JOB PROGRAM

1 Press the [#P] key.

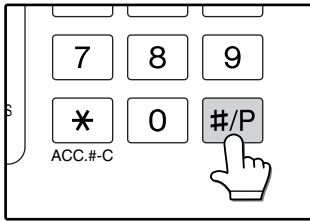

2 Touch the program number key of the desired program.

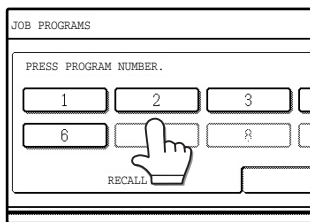

The job program will be executed. A number for which no job program has been stored cannot be selected.

3 Place the original, check the original size, and then set the number of copies and any other desired copy settings not stored in the program. When finished, press the [START] key (⏻).

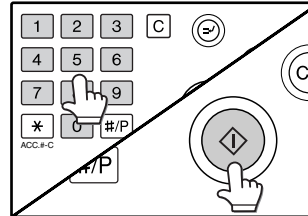

DELETING A STORED JOB PROGRAM

1 Press the [#P] key.

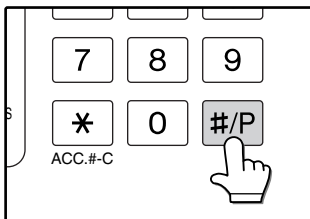

2 Touch the [STORE/DELETE] key.

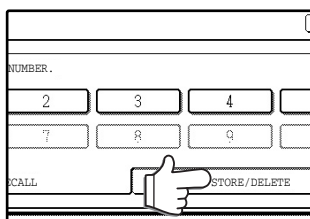

3 Select the program number of the program to be deleted.

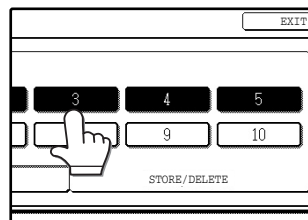

If a number key for which no job program has been stored is selected, the proceed to step 4 on the previous page (for storing a job program).

4 Touch the [DELETE] key.

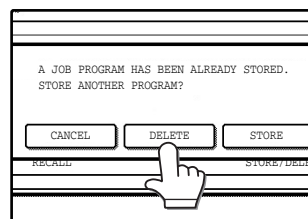

The selected program will be deleted and you will return to the screen of step 3. If the [CANCEL] key is touched, you will return to the screen of step 3 without deleting the program.

If you are finished deleting programs, touch the [EXIT] key in the screen of step 3 to exit.

AUDITING MODE

When auditing mode is enabled, a count is kept of the number of pages printed or copied by each account (maximum of 100 accounts). The counts can be viewed whenever necessary.



- Auditing mode can be enabled for all modes (copy mode, fax mode, network scanner mode, and printer mode) in the key operator programs. (See the "Key operator's guide".)
- To print in printer mode when auditing mode is enabled, enter your account number in the printer driver setup screen on your computer.

COPYING WHEN AUDITING MODE IS ENABLED

When auditing mode is enabled, the following account number entry screen appears.

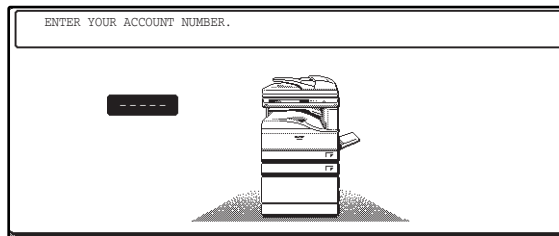

1 Enter your account number (5 digits) with the numeric keys.

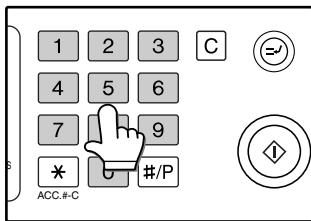

Each digit is indicated by an asterisk "*".

2 When the copy job is finished, press the [ACC.#-C] key ([*]).

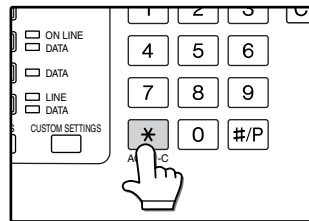

The screen reverts to the account number entry screen.

4

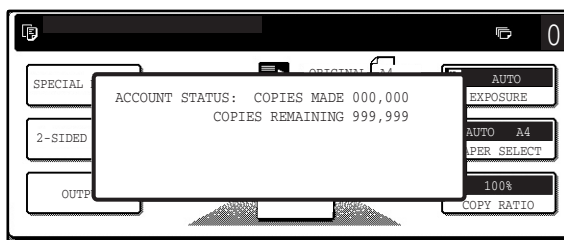

- When a valid account number is entered, the number of copies already made by that account appears for several seconds on the initial screen.
- If a limit has been set in the key operator programs for the number of copies that can be made by the account, the remaining number that can be made is displayed in the message display together with the number of copies already made. (See the "Key operator's guide".)



- To perform an interrupt job when auditing mode is enabled, press the [INTERRUPT] key (⊖). The account number entry screen will appear. Enter your account number. When the interrupt job is finished, be sure to press the [INTERRUPT] key (⊖) or the [CLEAR ALL] key (⊕) to end interrupt mode.
- If an invalid account number is entered in step 1, the account number entry screen reappears.
- When ACCOUNT NUMBER SECURITY in the key operator programs is enabled (See the "Key operator's guide".), the following message will appear and operation will not be permitted for 1 minute if an invalid account number is entered 3 times in a row.

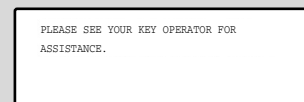

5

Chapter 5

TROUBLESHOOTING AND MAINTENANCE

This chapter describes troubleshooting and maintenance such as misfeed removal, replacing the toner cartridge and cleaning the machine.

DISPLAY MESSAGES	59
TROUBLESHOOTING	61

Trouble	Page	
Problems related to machine operation		
The machine does not operate.	61	
The power is on but copying is not possible.		
Two-sided copying is not possible.		
Wrong paper size is displayed for paper in the bypass tray.		
A copy job stops before it is finished.		
The contrast of the touch panel is too high or too low.		
Image cannot be rotated.		
Original size is not selected automatically, or copying does not take place on paper that matches the original size.	62	
Paper size for a paper tray cannot be set.		
Order of copies is incorrect.		
The job is cancelled after the originals were being scanned.		
Not all pages are copied.		
The RSPF cannot be used.		
Lighting fixture flickers.	63	
Paper feeding problems		
When using paper fed from the bypass tray, the copied image is skewed.		
Paper from the bypass tray misfeeds.	64	
Paper misfeeds.		
Image quality problems		
Copies are too dark or too light.	64	
Text is not clear in a copy.		
Part of the copied image is cut off.		
Blank copies.		
Paper is wrinkled or the copied image comes off when the paper surface is rubbed.		
Copies are smudged or dirty.		
White or black lines appear copies.		

MISFEED REMOVAL	65
REPLACING THE TONER CARTRIDGE	73
STAPLE CARTRIDGE REPLACEMENT	74
STAPLE JAM REMOVAL	75
CHECKING THE TONER QUANTITY AND TOTAL COUNT	75
CLEANING THE MACHINE	76
DOCUMENT GLASS AND DOCUMENT COVER/RSPF	76
THE BYPASS TRAY PAPER FEED ROLLER.....	76

DISPLAY MESSAGES

If one of the following messages appears in the display, take prompt action as instructed by the message.

Message	Cause and solution	Page
ENTER YOUR ACCOUNT NUMBER.	Auditing mode is enabled. Enter your account number.	57
A MISFEED HAS OCCURRED.	Remove the misfeed as explained in "MISFEED REMOVAL".	65
2-SIDED COPIES CANNOT BE MADE ON THIS PAPER TYPE.	This appears when you attempt to make two-sided copies on special paper that cannot be used for two-sided copying. Cancel two-sided copying or change the paper.	15, 27
REMOVE PAPER FROM THE <*>TRAY.	The indicated output tray is full. Remove the output from the tray. (<*> indicates the tray that is full.)	-
CLOSE THE <*> COVER.	The indicated cover is open. Close the cover. (<*> indicates the cover that is open.)	-
PLEASE EXTEND BYPASS-TRAY.	When copying from the bypass tray, be sure to pull out the bypass tray extension.	18
COVER SHEETS MUST BE THE SAME SIZE AS THE COPY PAPER USED.	When adding a cover, load paper in the bypass tray that is the same size as the paper in the tray selected for copying.	48
TONER SUPPLY IS LOW.	The toner cartridge must be replaced soon.	73
CHANGE THE TONER CARTRIDGE.	The toner cartridge is out of toner. Replace the toner cartridge.	73
CHECK THE TONER CARTRIDGE.	Make sure that the toner cartridge is installed correctly.	73
THE DOCUMENT FEEDER IS DISABLED.	The RSPF has been disabled in the key operator programs. Use the document glass.	22
SELECTED PAPER TRAY IS PROHIBITED. PLEASE SELECT ANOTHER PAPER TRAY.	This appears when a tray is selected that has been prohibited in "TRAY SETTINGS" in the custom settings.	54
PLEASE CHECK THE PAPER SIZE OF TRAY <***>.	The tray's paper size setting is different from the actual paper size. Load the correct size of paper. The tray is indicated in <***>.	15
ADD STAPLES.	The finisher is out of staples. Replace the staple cartridge as explained in "STAPLE CARTRIDGE REPLACEMENT".	74
PLEASE REMOVE PAPER FROM THE STAPLER COMPILER.	Paper remains in the stapler compiler. Remove the paper.	71
MEMORY IS FULL. PRESS [START] TO BEGIN COPYING OR [CA] TO CANCEL.	The memory becomes full while scanning originals. Press the [START] key (Ⓢ) to copy only the originals that have been scanned, or press the [CLEAR ALL] key (Ⓢ) to cancel the job.	-

Message	Cause and solution	Page
SELECTED PAPER TRAY IS OUT OF SERVICE.	Contact your authorised service representative.	-
CHECK STAPLER POSITION OR STAPLE JAM.	Staples are jammed in the finisher or the staple case is not attached correctly. Check the staple case. If the message still appears after removing the jammed staples, disable the stapler using "DISABLING OF STAPLER" in the key operator programs (See the "Key operator's guide."), and contact your authorised service representative.	75
(CALL FOR SERVICE SOON.)	It will soon be time for regular maintenance. Contact your authorised service representative.	-
(MAINTENANCE REQUIRED.)	It is time for regular maintenance. Contact your authorised service representative.	-
CALL FOR SERVICE. CODE: **-**	Turn off the power and then turn it back on. If this does not clear the message, write down the 2-digit main code and 2-digit sub-code and promptly contact your authorised service representative.	-
PLEASE CHECK THE ORIGINAL SIZE. JOB IS CANCELED.	The original in the RSPF is longer than the size that was detected. Reinsert the original, make sure that the size indicated in the touch panel is the same as the actual size, and begin copying. You can also select mixed feeding to copy onto paper that matches each original size after all originals have been scanned.	-

TROUBLESHOOTING

If you experience difficulty using the machine, check the following troubleshooting guide before calling for service. Many problems can be easily resolved by the user. If you are unable to solve the problem using the troubleshooting guide, turn off the power switch, unplug the machine, and contact your authorised service representative. The following problems are related to the general operation of the machine and copying. For problems related to the printer, fax, and network scanner functions, see the corresponding operation manuals.

Problems related to machine operation

Problem	Cause and solution	Page
The machine does not operate.	Power switch OFF. → Turn the power switch ON.	13
	The machine is warming up. → The machine requires about 23 seconds to warm up after the power switch is turned on. While the machine is warming up, copy settings can be selected but copying is not possible. Wait until "READY TO COPY." appears.	13
	Out of paper. → Load paper.	17
	Out of toner. → Replace the toner cartridge.	73
	Misfeed occurs. → Remove the misfed paper.	65
The power is on but copying is not possible.	The machine is in auto power shut-off mode. → If only the [START] key (Ⓢ) blinks, auto power shut-off mode has activated. Press the [START] key (Ⓢ) to return the machine to normal operation.	14
	Copy mode is not selected. → Press the [COPY] key to select copy mode.	10
Two-sided copying is not possible.	Automatic two-sided copying was attempted on paper that is not suitable for automatic two-sided copying. → Two-sided copying is not possible on special paper. Use paper that is suitable for automatic two-sided copying.	27
	Two-sided copying is prohibited in the key operator programs. → Change the setting in the key operator programs to permit two-sided copying.	Key operator's guide
Wrong paper size is displayed for paper in the bypass tray.	The bypass tray extension is not pulled out. → To detect the paper size correctly, the bypass tray extension must be pulled out when the paper is loaded.	18
A copy job stops before it is finished.	Too many pages have accumulated in the output tray, causing the tray full sensor to activate. Further copying is not possible until the pages are removed. → Remove the pages from the output tray.	-
The contrast of the touch panel is too high or too low.	The display contrast has not been adjusted. → Adjust the contrast using "DISPLAY CONTRAST" in the custom settings.	54
Image cannot be rotated.	Neither auto paper selection nor auto image mode are selected. → Rotation copy functions only if auto paper select mode or auto image mode is selected.	25, 30
	Rotation copy is prohibited in the key operator programs. → Change the setting in the key operator programs to permit rotation copying.	Key operator's guide

Problem	Cause and solution	Page
<p>Original size is not selected automatically, or copying does not take place on paper that matches the original size.</p>	<p>The document cover/RSPF was not opened completely when the original was placed on the document glass. → Open the document cover/RSPF completely, place the original on the document glass, and close the RSPF.</p>	-
	<p>The original contains large black solid areas. → If the original contains any large black solid areas, the original size may not be detected automatically. Use the [SPECIAL MODES] key to select the original size.</p>	47
	<p>The original is smaller than A5 (5-1/2" x 8-1/2") size. → When the original is smaller than A5 (5-1/2" x 8-1/2") size, the size cannot be detected. Use the [PAPER SELECT] key to select the desired paper size.</p>	22
	<p>The original is not a standard size. → When the original is not a standard size, the size cannot be detected. Manually select the closest standard original size, or use the [PAPER SELECT] key to select the desired paper size.</p>	22, 47
<p>Paper size for a paper tray cannot be set.</p>	<p>A copy, print job, or received fax is being printed. → Set the correct paper size after printing is finished.</p>	-
	<p>Operation has temporarily stopped because the tray is out of paper or a misfeed occurred. → Load paper or remove the misfeed, finish the copy job, and then set the paper size.</p>	19, 65
	<p>During an interrupt copy job. → Set the correct paper size after the interrupt copy job is finished.</p>	34
	<p>Misfeed occurs. → Remove the misfed paper.</p>	65
	<p>Paper tray settings are prohibited in the key operator programs. → Change the setting in the key operator programs to permit paper tray settings.</p>	Key operator's guide
<p>Order of copies is incorrect.</p>	<p>The originals were placed in the wrong order. → When using the document glass, scan the originals one sheet at a time beginning from the first page. When using the RSPF, insert the originals with the first page on top and facing up.</p>	23
<p>The job is cancelled after the originals were being scanned.</p>	<p>The memory become full while the originals were being scanned. → When using a function such as pamphlet copy or multi shot copy where all original pages are scanned into memory before copying begins, scanning will stop and copying will not take place if the memory becomes full. The number of pages that can be scanned into memory can be increased by installing more memory.</p>	77
<p>Not all pages are copied.</p>	<p>The memory become full while the originals were being scanned. → When the memory becomes full while the originals are being scanned, you can select whether you want to continue the job and print only those originals that were scanned, or cancel the job. If you continue the job, copies will only be made of the originals that were scanned, and thus all originals cannot be copied at once.</p>	-
<p>The RSPF cannot be used.</p>	<p>Use of the RSPF has been prohibited in the key operator programs. → Enable use of the RSPF in the key operator programs.</p>	Key operator's guide
<p>Lighting fixture flickers.</p>	<p>The same power outlet is used for the lighting fixture and the machine. → Connect the machine to a power outlet which is not used for other electric appliances.</p>	4

Paper feeding problems

Problem	Cause and solution	Page
When using paper fed from the bypass tray, the copied image is skewed.	The number of sheets placed on the bypass tray exceeds the maximum number. → Do not place more than the maximum number of sheets.	15
	The bypass guide is not adjusted to the size of the loaded paper. → Adjust the bypass guide to the size of the loaded paper.	18
Paper from the bypass tray misfeeds.	The paper type setting is not correct. → When using a special paper, be sure to set the correct paper type.	20
	The number of sheets placed on the bypass tray exceeds the maximum number. → Do not place more than the maximum number of sheets.	15
	The bypass guide is not adjusted to the size of the loaded paper. → Adjust the bypass guide to the size of the loaded paper.	18
Paper misfeeds.	The paper is outside of the specified size and weight range. → Use copy paper within the specified range.	15
	Paper is curled or damp. → Do not use curled or crimped paper. Replace with dry copy paper. During periods when the machine is not used for a long time, remove the paper from the tray and store it in a dark place in a bag to prevent moisture absorption.	80
	Paper is not loaded properly. → Make sure the paper is properly loaded.	17
	Pieces of paper remain inside machine. → Remove all pieces of misfed paper.	65
	Sheets of paper stick together. → Fan the paper well before loading it.	17

Image quality problems

Problem	Cause and solution	Page
Copies are too dark or too light.	The image of the original is too light or too dark. → Select the correct original image type in the exposure setting and adjust the copying exposure.	29
	The copying exposure is set to "AUTO". → The "EXPOSURE ADJUSTMENT" key operator program can be used to adjust the exposure level used for "AUTO" exposure. Consult the administrator of the machine.	Key operator's guide
	The original type that is most suitable for the original has not been selected in the copy exposure setting screen. → Change the original image type selection to "AUTO", or manually select the most suitable original image type setting.	29
Text is not clear in a copy.	The correct original image type has not been selected in the copy exposure setting screen. → Change the original image type setting to "TEXT".	29
Part of the copied image is cut off.	The original was placed in the wrong position. → Place the original in the correct position. When using the document glass, place the original against the far left side.	22, 23
	A suitable ratio for the original size and paper size has not been selected. → Use auto ratio selection to obtain the correct ratio for the copy.	30
	The tray's paper size setting was not changed when a different size of paper was loaded in the tray. → Be sure to change the tray's paper size setting when loading a different size of paper in the tray.	19
	An inch paper size is being used. → When using copy paper that is an inch size, set the original size manually.	47
Blank copies.	The original is not placed face up in the RSPF or face down on the document glass. → Place the original face up in the RSPF or face down on the document glass.	22, 23
Paper is wrinkled or the copied image comes off when the paper surface is rubbed.	The paper is outside of the specified size and weight range. → Use copy paper within the specified range.	15
	The paper type setting is not correct. → Set the correct paper type. To set the paper type for a tray, see "CHANGING A TRAY'S PAPER TYPE AND PAPER SIZE SETTINGS".	19, 20
	Paper is curled or damp. → Do not use curled or wrinkled paper. Replace with dry copy paper. During periods when the machine is not used for a long time, remove the paper from the tray and store it in a dark place in a bag to prevent moisture absorption.	80
Copies are smudged or dirty.	The document glass or the underside of the RSPF is dirty. → Clean regularly.	76
	The original is smudged or blotchy. → Use a clean original.	-
White or black lines appear copies.	The scanner glass for the RSPF is dirty. → Clean the long, narrow scanning glass.	76

MISFEED REMOVAL

When a misfeed occurs during copying, the message "MISFEED HAS OCCURRED." will appear in the touch panel and printing will stop.

- If the misfed paper tears during removal, remove the torn pieces. Take care not to touch the photoconductive drum while removing the pieces. Nicks and scratches on the drum will cause dirty copies.

First, locate the misfeed

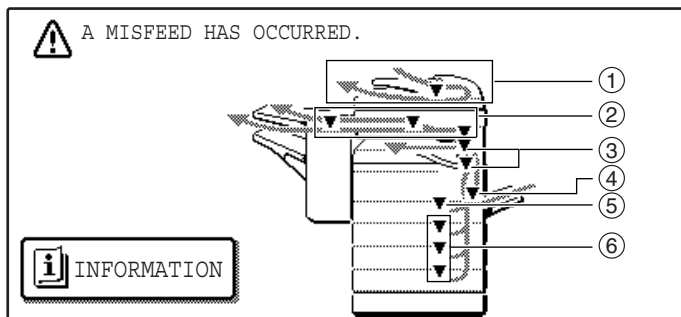

- ① Misfeed in the RSPF (p.66)
- ② Misfeed in the finisher (p.71)
- ③ Misfeed in the machine (p.67)
- ④ Misfeed in the bypass tray (p.67)
- ⑤ Misfeed in the upper paper tray (p.69)
- ⑥ Misfeed in the lower paper tray (p.70)



Note If the fax option is installed, all received faxes are stored in memory. The faxes are automatically printed after the misfeed is removed.

MISFEED REMOVAL GUIDANCE

Misfeed removal guidance can be displayed by touching the [INFORMATION] key on the touch panel after a misfeed has occurred.

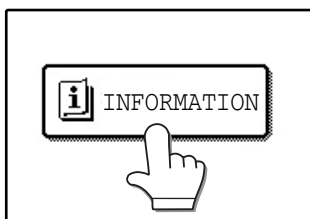

MISFEED IN THE RSPF

1 Remove the misfed original.

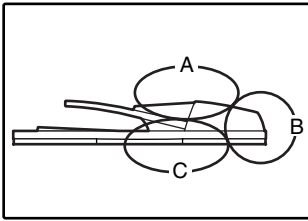

Check sections A, B, and C in the illustration at left and remove the misfed original.

Section A

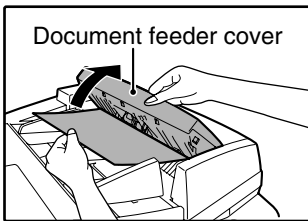

Open the document feeder cover and carefully remove the misfed original from the document feeder tray. Close the document feeder cover.

Section B

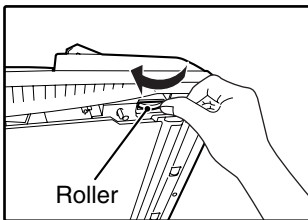

Open the RSPF and rotate the release roller in the direction of the arrow to feed the original out. Close the RSPF and then carefully remove the original.

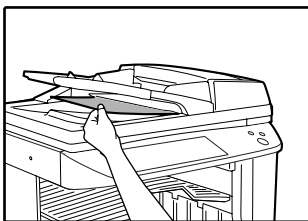

If the misfed original cannot be removed, open the document transport cover (below), and rotate the release roller again.

If a small original (5-1/2" x 8-1/2", etc.) is misfed, or if an original misfeed occurs in the reversing tray of the RSPF, lift the document transport cover knob, open the document transport cover, and remove the original.

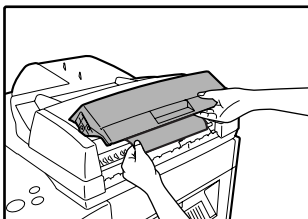
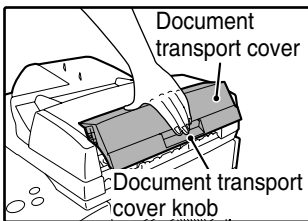

Section C

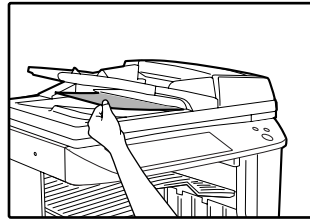

Carefully remove the misfed original from the exit area.

If the misfed original cannot be easily removed from the exit area, open the moveable part of the document feeder tray and remove the reversing tray, and then remove the original.

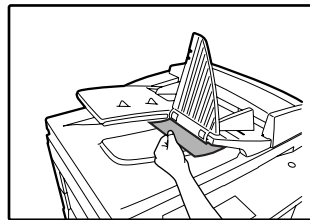
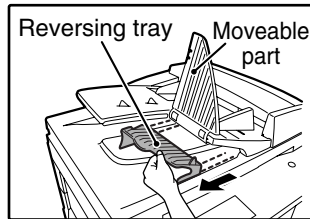

Note After removing a misfed original from the exit area, be sure to attach the reversing tray securely to the exit area (When the RSPF is installed.).

2 Open and close the RSPF to clear the misfeed message from the touch panel.

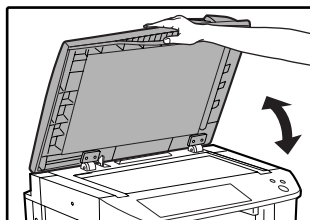

The message can also be cleared by opening and closing the document feeder cover or the document transport cover.

After the misfeed is removed and the misfeed message is cleared, a message will appear indicating the number of originals that must be reinserted in the RSPF.

3 Reinsert the originals that still must be scanned (Including the original that was being scanned when the misfeed occurred.), and press the [START] key (⏻).

Copying of the remaining originals will resume.

MISFEED IN THE BYPASS TRAY

- 1 Carefully pull the misfed paper out.

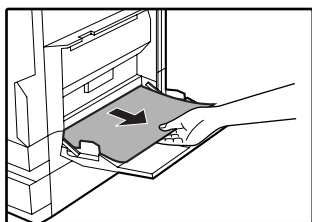

- 2 Open and close the side cover.

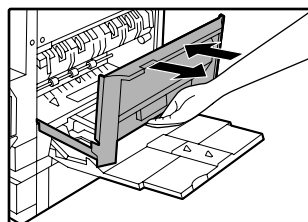

Make sure that the misfeed message is cleared.
The message can also be cleared by opening and closing the front cover.
If the message is not cleared, see "A. Misfeed in the paper feed area".

MISFEED IN THE MACHINE

Determine the location of the misfeed and remove it appropriately as indicated below.

If paper is misfeed here, go to "A. Misfeed in the paper feed area" (below).

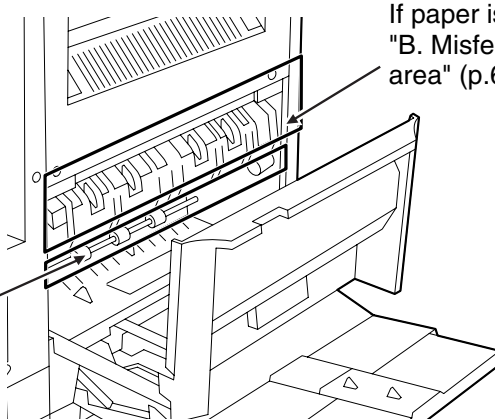

If paper is misfed, go to "B. Misfeed in the fusing area" (p.68).

A. Misfeed in the paper feed area

- 1 Open the bypass tray and the side cover.

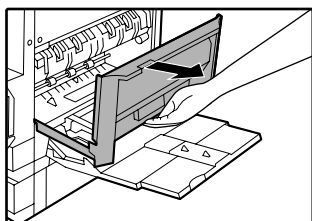

- 2 Press gently on both sides of the front cover and pull it open.

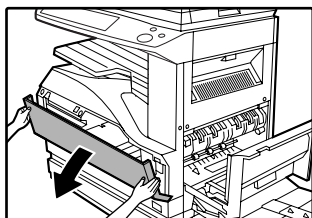

- 3 Carefully remove the misfed paper. Turn the roller rotating knob in the direction of the arrow to assist in removing it.

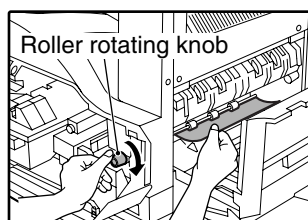

Be careful not to tear the misfed paper during removal.

Warning The fusing unit is hot. Do not touch the fusing unit when removing misfed paper. Doing so may cause a burn or injury.

Caution Do not touch the photoconductive drum (green portion) when removing the misfed paper. Doing so may damage the drum and cause smudges on copies.

4 Close the front cover and side cover.

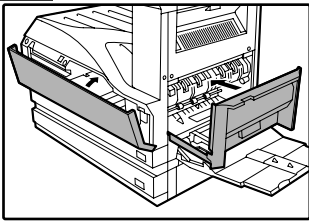

Make sure that the misfeed message is cleared.

B: Misfeed in the fusing area

1 Open the bypass tray and the side cover.

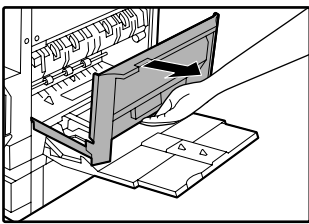

2 Press and pull it open gently on both sides of the front cover.

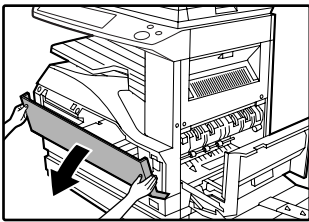

3 Turn the roller rotating knob in the direction of the arrow.

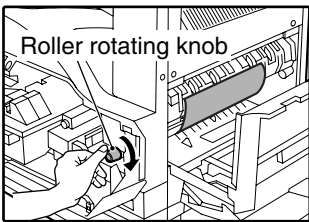

4 Lift the fusing unit release levers and carefully remove the misfed paper.

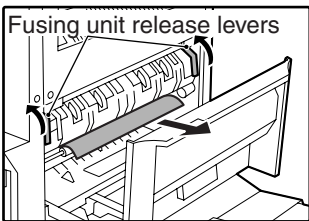

5 If you were unable to remove the misfeed in step 4, press down on the fusing unit paper guide knob to open the paper guide, and carefully remove the misfed paper.



Caution

- Do not touch the photoconductive drum (green portion) when removing the misfed paper. Doing so may damage the drum and cause smudges on copies.
- Take care not to let unfixed toner on the misfed paper soil your hands or clothes.

6 Close the fusing unit paper guide and press down on the fusing unit release levers.

7 Close the front cover and side cover.

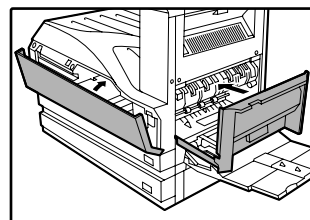

Make sure that the misfeed message is cleared.

Warning

The fusing unit is hot. Do not touch the fusing unit when removing misfed paper. Doing so may cause a burn or injury.

MISFEED IN THE CENTRE TRAY

Remove the paper by pulling it into the centre tray.

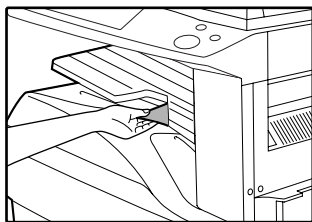

MISFEED IN THE UPPER PAPER TRAY

Make sure that there is no misfed paper in the machine before pulling the tray out. (p.67)

1 Lift and pull out the upper paper tray and then remove the misfed paper.

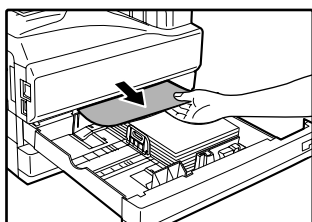

Be careful not to tear the misfed paper during removal.

2 Replace the upper paper tray.

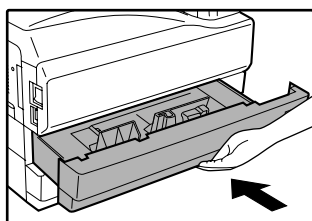

Push the upper paper tray in completely.

3 Open and close the side cover.

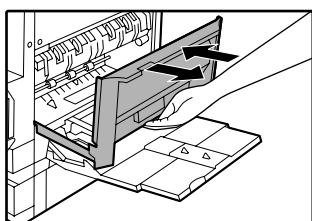

Make sure that the misfeed message is cleared.
The message can also be cleared by opening and closing the front cover.

MISFEED IN THE LOWER PAPER TRAY

- Make sure that there is no misfed paper in the machine before pulling the tray out. (p.67)
- Use the following procedure to remove misfeeds that occur in the 500-sheet paper feed unit or 2 x 500-sheet paper feed unit.

1 Open the lower side cover.

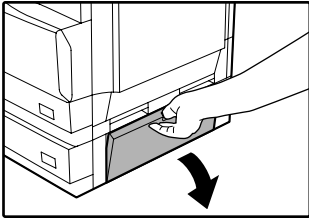

2 Remove the misfed paper.

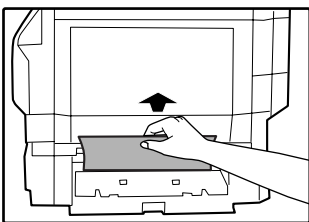

Be careful not to tear the misfed paper during removal.

3 If the misfed paper is not visible in step 2, lift and pull out the lower paper tray and remove the misfed paper.

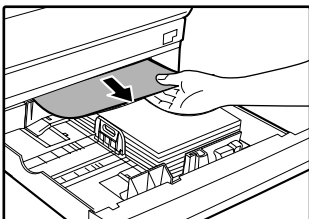

Be careful not to tear the misfed paper during removal.

4 Replace the lower paper tray.

Push the lower paper tray in completely.

5 Close the lower side cover.

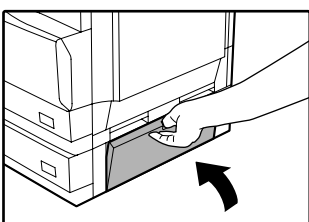

Make sure that the misfeed message is cleared.

MISFEED IN THE UPPER EXIT AREA (when a job separator tray kit or finisher (AR-FN5A) is installed)

If a job separator tray kit or a finisher is installed, a misfeed may occur in the upper exit area.

1 Open the upper right side cover.

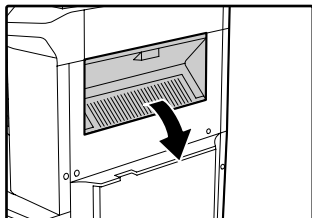

3 Close the upper right side cover.

Make sure that the misfeed message is cleared.

2 Gently pull the misfed paper out.

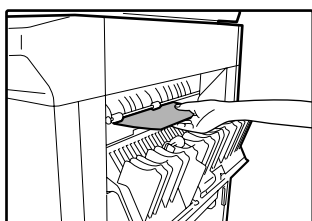

Be careful not to tear the misfed paper during removal.

MISFEED IN AN OUTPUT TRAY (when a finisher (AR-FN5A) is installed)

5

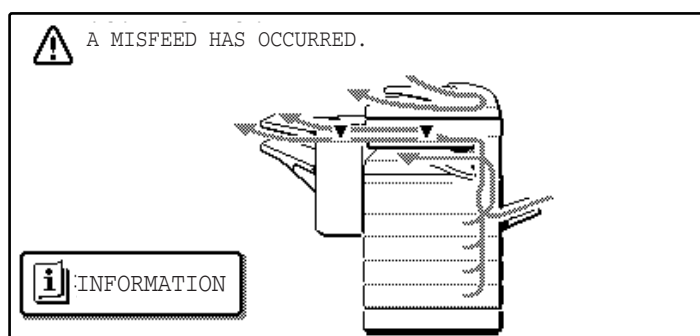

1 Grasp the handle of the stapler compiler cover and pull to open the cover.

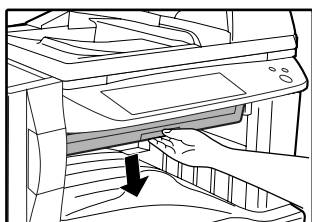

2 Remove any misfed paper from the transport area.

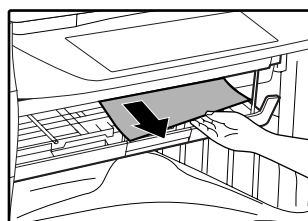

- 3** If staple sort copying is being performed, open the paper guide and remove any misfed paper from the stapler compiler.

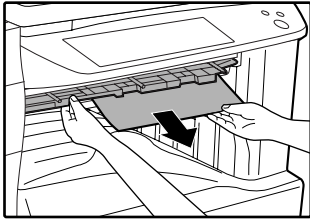

- 4** Close the stapler compiler cover.

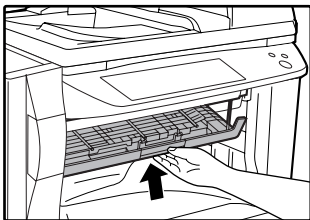

- 5** If the offset tray is being used, remove any misfed paper from the offset tray.

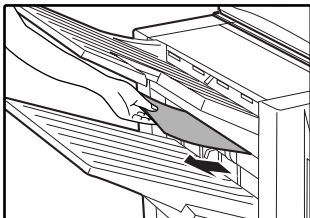

- 6** If the top tray is being used, open the top cover, remove any misfed paper, and close the top cover.

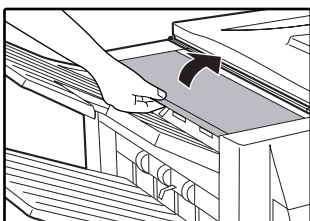

Make sure that the misfeed message is cleared.

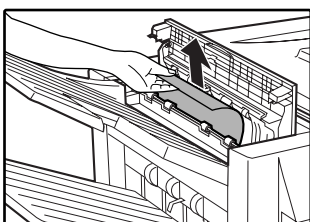

REPLACING THE TONER CARTRIDGE

To check how much toner remains in the toner cartridge (p.75), hold down the [COPY] key. The amount of toner remaining will appear in the display. When less than 25% of the toner remains, obtain a new toner cartridge as soon as possible. When "TONER SUPPLY IS LOW." appears in the display, be sure to have a new cartridge on hand for replacement at any time as little toner remains. When "CHANGE THE TONER CARTRIDGE." appears in the touch panel, the toner cartridge must be replaced. Follow these steps to replace the cartridge.

! Caution

- Do not throw the toner cartridge into a fire. Toner may fly and cause burns.
- Store toner cartridges out of the reach of small children.

Note

When running long copy jobs or copying originals with many areas of solid black, "TONER REPLENISHMENT IN PROGRESS." may appear in the touch panel and copying may stop even though the cartridge still has toner. When this occurs, the toner is being replenished. Replenishment will last about two minutes. When the [START] key (Ⓢ) illuminates, press the [START] key (Ⓢ) to resume copying.

1 Press gently on both sides of the front cover and pull it open.

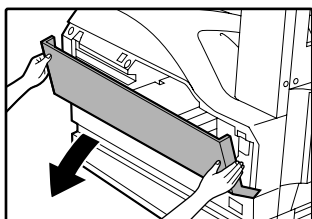

2 Pull the toner cartridge out while pressing the lock release lever.

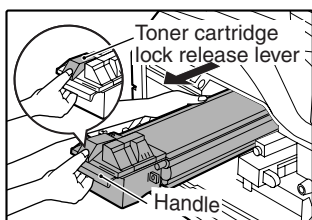

When pulling out the toner cartridge, place your other hand on the green part of the cartridge.

Note

- After removing the toner cartridge, do not shake it or tap it. Doing so may cause toner to leak from the cartridge. Put the old cartridge immediately in the bag provided with the new cartridge.
- Dispose of the old toner cartridge in accordance with local regulations.

3 Remove the new toner cartridge from the bag. Grasp both ends of the cartridge and shake it horizontally about 20 times. After shaking the cartridge, remove the tape.

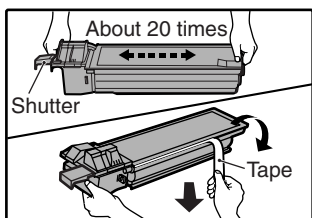

Grasp the hand grip to hold the cartridge. Do not hold the cartridge by the shutter. Be sure to only shake the cartridge before the tape is removed.

4 While pushing the lock release lever, gently insert the toner cartridge along the guides until it clicks into place.

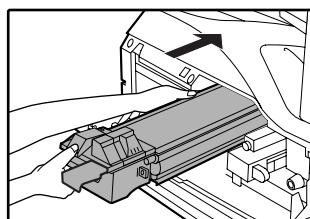
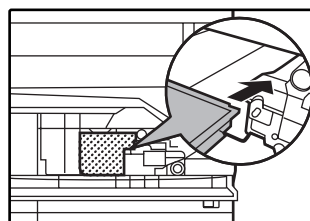

Note

If dirt or dust adheres to the toner cartridge, remove it before installing the cartridge.

5 Remove the tape from the shutter. Pull the shutter out of the toner cartridge as shown in the illustration.

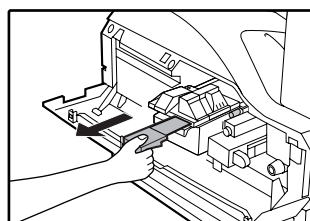

Discard the shutter.

6 Close the front cover.

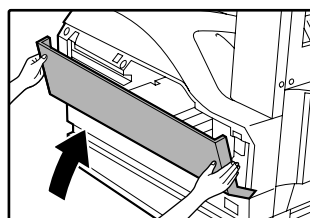

5

STAPLE CARTRIDGE REPLACEMENT

(when the finisher (AR-FN5A) is installed)

When the message "ADD STAPLES." appears, replace the staple cartridge as follows:

1 Open the stapler cover.

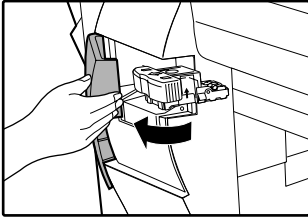

2 Grasp the green portion of the staple box and remove the staple box from the stapler.

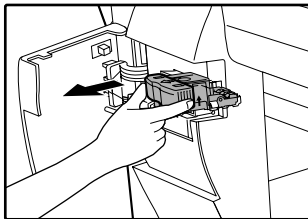

3 Remove the staple cartridge from inside the staple box.

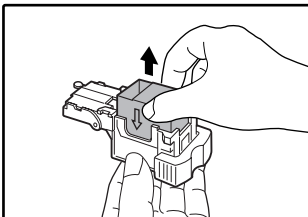

4 Insert the new staple cartridge into the box until it clicks into place.

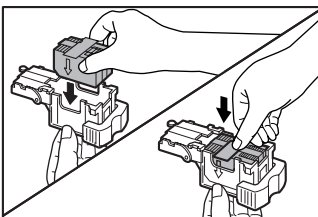

Insert the new cartridge by aligning the arrows on the cartridge with those on the box. Check that the cartridge has locked into place by pulling it slightly.

5 Remove the tape from the cartridge.

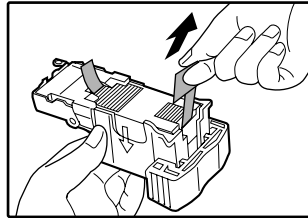

6 Insert the staple box into the stapler unit until it clicks into place.

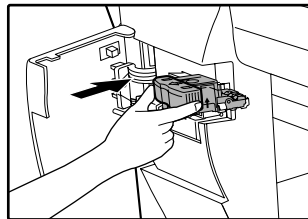

7 Close the stapler cover.

STAPLE JAM REMOVAL

If staples become jammed in the stapler, the message "CHECK STAPLER POSITION OR STAPLE JAM." will appear. Follow these steps to remove the jammed staples.

1 Open the stapler cover.

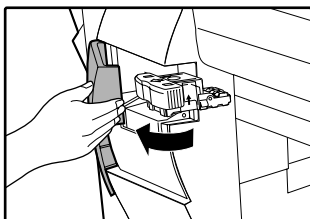

2 Grasp the green portion of the staple box and remove the staple box from the stapler.

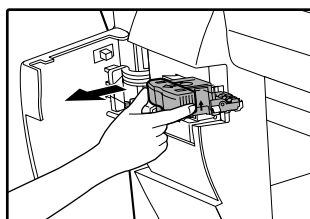

3 Raise the lever at the end of the staple box and remove the jammed staples.

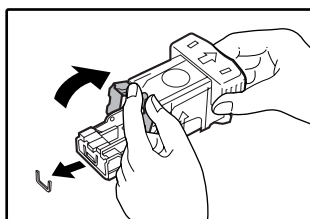

4 Return the lever to its original position.

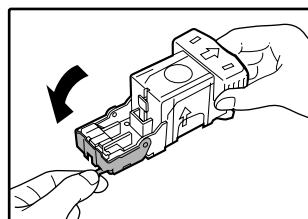

5 Insert the staple box into the stapler unit until it clicks into place.

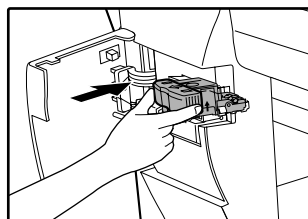

6 Close the stapler cover.

5

CHECKING THE TONER QUANTITY AND TOTAL COUNT

The approximate quantity of toner remaining and the total count can be displayed as explained below.

- The total count shows the combined output total of the copy, fax, and printer functions.

Checking the total count and toner quantity

Hold down the [COPY] key. The total count and toner quantity appear while the key is held down.

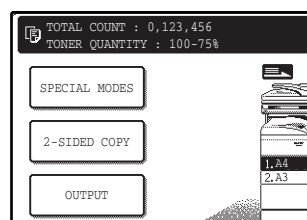
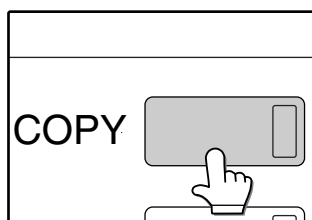

- Each A3 (11" x 17") page is counted as two pages. Two sided pages are also counted as two pages.
- The amount of toner consumed will vary depending on conditions of usage and the type of originals copied. The toner quantity display should only be used as an approximate guide.

CLEANING THE MACHINE

DOCUMENT GLASS AND DOCUMENT COVER/RSPF

If the document glass, document cover/RSPF, or scanning glass for originals fed from the RSPF (the long narrow glass surface on the right side of the document glass) become dirty, the dirt may appear on copies. Always keep these parts clean.

Stains or dirt on the document glass/document cover/RSPF will also be copied. Wipe the document glass, the document cover, RSPF and the scanning window on the document glass with a soft, clean cloth.

If necessary, dampen the cloth with water. Do not use thinner, benzene, or similar volatile cleaning agents.



Do not spray flammable cleaner gas. Gas from the spray may come in contact with the internal electrical components or high-temperature parts of the fusing unit, creating a risk of fire or electrical shock.

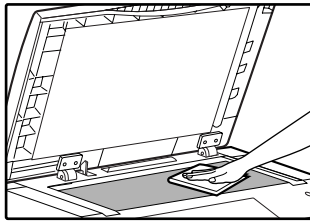

Surface of document glass

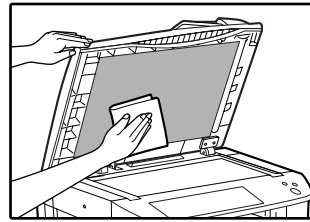

Underside of document cover/RSPF

Cleaning the scanning glass for RSPF (only when an RSPF is installed)

If white or black lines appear in copies made with using the RSPF, use the provided glass cleaner to clean the scanning glass for RSPF.

Example of dirty print image

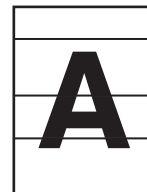

Black lines



White lines

1 Open the RSPF and take out the glass cleaner.

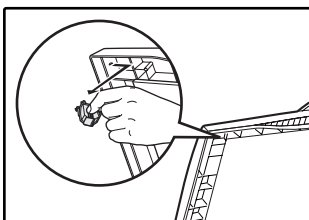

2 Clean the scanning glass with the glass cleaner.



3 Return the glass cleaner to its original position.

THE BYPASS TRAY PAPER FEED ROLLER

If misfeeds occur frequently when feeding envelopes or other thick paper from the bypass tray, wipe the paper feed roller at the feed slot of the bypass tray with a soft, clean cloth moistened with alcohol or water.

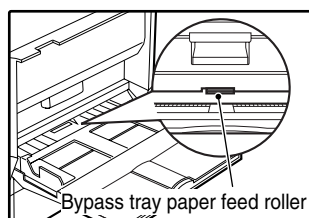

Optional equipments and supplies are explained in this chapter. To purchase optional equipment and supplies contact your authorised service representative.

PERIPHERAL DEVICES

FINISHER (AR-FN5A) See page 78.
500-SHEET PAPER FEED UNIT (AR-D30) See page 79.
2 x 500-SHEET PAPER FEED UNIT (AR-D31) See page 79.
DOCUMENT COVER (AR-VR6)
REVERSING SINGLE PASS FEEDER (AR-RP7) See page 80.
SADDLE STITCH FINISHER (AR-F14N) The staple and pamphlet staple functions can be used. For detailed information, see the manual that accompanies the saddle stitch finisher.
JOB SEPARATOR TRAY KIT (AR-TR3) This enables separation of output locations by mode (copy, printer, etc.).
PRINTER EXPANSION KIT (AR-P27) This allows the machine to be used as a network printer.
APPLICATION INTEGRATION MODULE KIT (MX-AMX1) The application integration module can be used in combination with the network scanner function to attach metadata to a scanned image file before it is transmitted.
MACRO FONT FLASH ROM KIT (AR-PF2) Fonts and forms can be downloaded and stored.
PS3 EXPANSION KIT (AR-PK1N)*1 This kit offers PostScript 3 compatibility.
BARCODE FONT KIT (AR-PF1)*1 This font set adds barcode printing capability.
NETWORK SCANNER EXPANSION KIT (MX-NSX1)*2 This allows the machine to be used as a network scanner.
FACSIMILE EXPANSION KIT (AR-FX7) This allows the machine can be used as a facsimile machine.
8MB FAX MEMORY (AR-MM9) Image memory can be expanded by installing the optional fax expansion memory.
256MB EXPANSION MEMORY BOARD (AR-SM5) 512MB EXPANSION MEMORY BOARD (AR-SM6) Additional memory can be installed in the machine. There are two DIMM slots in this machine, and the memory can be expanded to a maximum of 1056 MB.

*1 Requires installation of the PRINTER EXPANSION KIT (AR-P27).

*2 Requires installation of the PRINTER EXPANSION KIT (AR-P27), and 128MB or more of memory must be extended.



- A commercial 64/128/256/512MB (the 168 pin SDRAM DIMM) memory module can be used to expand memory in this unit. For more information, consult your authorised service representative.
- The peripheral devices are generally optional, however, some models include certain peripheral devices as standard equipment.

FINISHER (AR-FN5A)

When an optional finisher (AR-FN5A) is installed, the machine can automatically staple the sorted copies. Each collated set of copies or group of copies can be stacked offset from the previous set. (Offset function p.35)

Part names

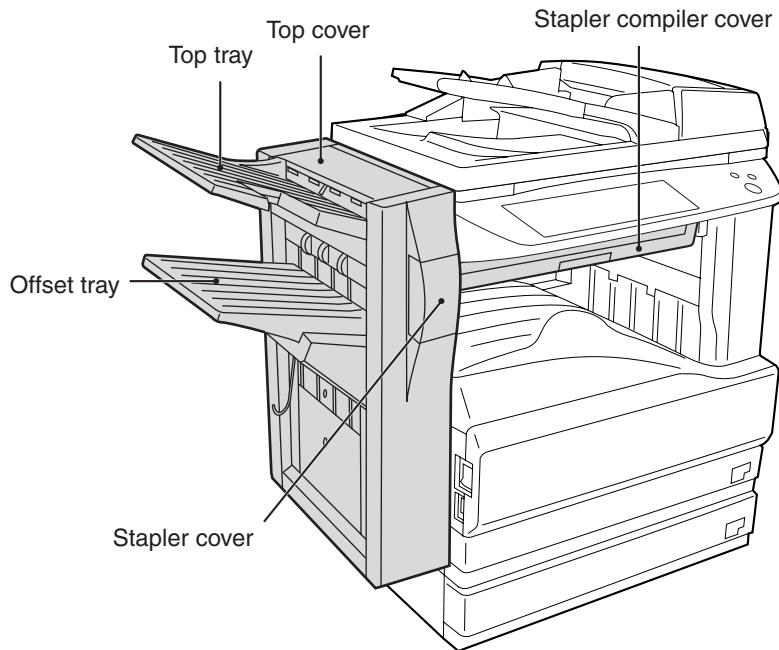

Specifications

	AR-FN5A	
Tray capacity	Top tray	100 sheets
	Offset tray	1,000 sheets (500 sheets for sizes larger than A4 (8-1/2" x 11"))
Paper size	Size	Top tray: A5 to A3 (5-1/2" x 8-1/2" to 11" x 17")
		Offset tray: B5 to A3 (8-1/2" x 11" to 11" x 17")
	Weight	52 g/m ² to 128 g/m ² (14 lbs. to 34 lbs.)
Offset	Approx. 27 mm (1")	
Paper sizes that can be stapled	B5, A4, A4R, B4, A3 (8-1/2" x 11", 8-1/2" x 11"R, 8-1/2" x 13", 8-1/2" x 14", 11" x 17")	
Stapling capacity	30 sheets (80 g/m ² (21 lbs.))	
Power supply	Drawn from the machine	
Weight	Approx. 19 kg (42 lbs.)	
Dimensions	Exit area	470 mm (W) x 511 mm (D) x 540 mm (H) (18-33/64" (W) x 20-1/8" (D) x 21-17/64" (H))
	Stapler compiler	562 mm (W) x 444 mm (D) x 109 mm (H) (22-9/64" (W) x 17-31/64" (D) x 4-19/64" (H))



As a part of our policy of continuous improvement, SHARP reserves the right to make design and specification changes for product improvement without prior notice. The performance specification figures indicated are nominal values of production units and there may be some deviations from these values in individual units.

500-SHEET PAPER FEED UNIT/ 2 x 500-SHEET PAPER FEED UNIT

These paper feed units provide the convenience of increased paper capacity for the machine and a greater choice of paper sizes readily available for copying.

The AR-D30 contains one 500-sheet paper tray and the AR-D31 contains two 500-sheet paper trays.

Part names

500-SHEET PAPER FEED UNIT
(AR-D30)

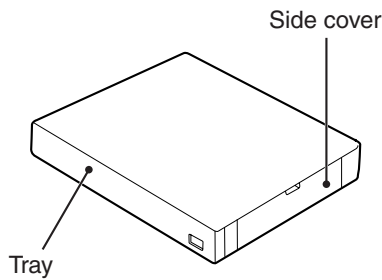

2x500-SHEET PAPER FEED UNIT
(AR-D31)

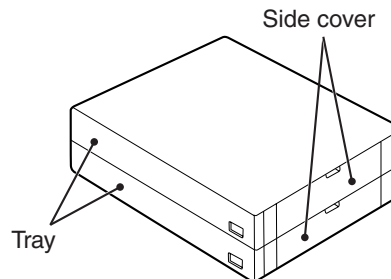

Specifications

		AR-D30	AR-D31
Paper	Size	B5 to A3 (8-1/2" x 11" to 11" x 17")	
	Weight	56 g/m ² to 105 g/m ² (15 lbs. to 28 lbs.)	
Paper capacity	Upper tray	500 sheets	500 sheets
	Lower tray	—	500 sheets
Weight		Approx. 6.1kg (13.5 lbs.)	Approx. 11.8kg (26.1 lbs.)
Dimensions		596 mm (W) x 498 mm (D) x 97 mm (H) (23-15/32" (W) x 19-39/64" (D) x 3-53/64" (H))	596 mm (W) x 498 mm(D) x 194 mm(H) (23-15/32" (W) x 19-39/64" (D) x 7-53/64" (H))
Power supply		Drawn from the machine	



As a part of our policy of continuous improvement, SHARP reserves the right to make design and specification changes for product improvement without prior notice. The performance specification figures indicated are nominal values of production units and there may be some deviations from these values in individual units.

REVERSING SINGLE PASS FEEDER

The reversing single pass feeder (RSPF) can automatically feed multi-page documents. If the RSPF is installed, two-sided originals can be copied automatically without having to manually turn them over.

Part names

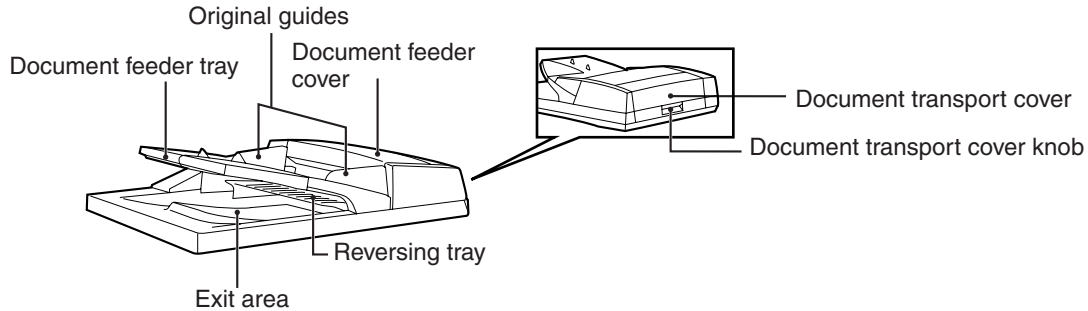

Specifications

		AR-RP7
Acceptable originals	Weight	35 g/m ² to 128 g/m ² (9 lbs. to 34 lbs.) (52 g/m ² to 105 g/m ² (14 lbs. to 28 lbs.) for two-sided original)
	Size	A5 to A3 (5-1/2" x 8-1/2" to 11" x 17")
	Capacity	Up to 100 sheets (Thickness 13 mm (33/64) and below)
Power supply		Drawn from the machine
Detectable original sizes		A5 to A3 (5-1/2" x 8-1/2" to 11" x 17")
Weight		Approx. 7.9 kg (17.4 lbs.)
Dimensions		586 mm (W) x 457 mm (D) x 145 mm (H) (22-61/64" (W) x 17-9/64" (D) x 5-1/4" (H))



As a part of our policy of continuous improvement, SHARP reserves the right to make design and specification changes for product improvement without prior notice. The performance specification figures indicated are nominal values of production units and there may be some deviations from these values in individual units.

STORAGE OF SUPPLIES

Standard supplies for this product that are to be replaced by the user are paper and the toner cartridge.

SHARP



GENUINE SUPPLIES

For best copying results, be sure to use only SHARP products. Only genuine SHARP consumables carry the Genuine Supplies label.

PROPER STORAGE

Store the supplies in a location that is:

- clean and dry,
- at a stable temperature,
- not exposed to direct sunlight.

Store paper in the wrapper and lying flat.

Paper stored out of the wrapper or in packages standing on end may curl or get damp, resulting in paper misfeeds.

Supply and Consumables

The supply of spare parts for a repair of the appliance is guaranteed for at least 7 years following the termination of production. Spare parts are those parts of the apparatus which may break down within the scope of the ordinary use of the product - whereas those parts which normally exceed the life of the product are not to be considered as spare parts. Consumables too, are available for 7 years following the termination of production.

SPECIFICATIONS

Model	AR-M256	AR-M316
Type	Digital Multifunction System, Desktop	
Photoconductive type	OPC drum	
Document glass type	Fixed	
Copy system	Dry, electrostatic transfer	
Originals	Sheets, bound documents	
Originals size	Max. A3 (11" x 17")	
Copy size	Max. A3 (11" x 17") Min. A6 (5-1/2" x 8-1/2") Image loss: Max. 4 mm (5/32") (leading and trailing edges) Max. 6 mm (11/64") (along other edges in total)	
Copying speed (one-sided copying at 100% copy ratio)	13 copies/min. A3 (11" x 17") 15 copies/min. B4 (8-1/2" x 13", 8-1/2" x 14") 18 copies/min. A4R (8-1/2" x 11"R) 20 copies/min. B5R 25 copies/min. A5, B5, A4 (5-1/2" x 8-1/2", 8-1/2" x 11")	17 copies/min. A3 (11" x 17") 20 copies/min. B4 (8-1/2" x 13", 8-1/2" x 14") 24 copies/min. A4R, B5R (8-1/2" x 11"R) 31 copies/min. A5, B5, A4 (5-1/2" x 8-1/2", 8-1/2" x 11")
Continuous copy	Max. 999 copies; subtractive counter	
First-copy time^{*1}	Approx. 4.8 sec. (When A4 (8-1/2" x 11") size paper is fed horizontally from tray1)	Approx. 4.5 sec. (When A4 (8-1/2" x 11") size paper is fed horizontally from tray1)
Warm-up time^{*2}	Approx. 23 sec.	Approx. 25 sec.
Copy ratio	Variable: 25% to 400%, in 1% increments (total 376 steps) Fixed preset: 25%, 50%, 70%, 81%, 86%, 100%, 115%, 122%, 141%, 200%, 400% (25%, 50%, 64%, 77%, 100%, 121%, 129%, 200%, 400%)	
Exposure system	Document glass: Moving optical source, slit exposure (stationary platen) with automatic exposure function RSPF: Moving original	
Paper feed	Two automatic feeding paper trays (500 sheets x 2) + bypass tray (100 sheets)	
Fusing system	Heat rollers	
Developer system	Magnetic brush development	
Light source	Xenon lamp	
Resolution	Scan: 400 dpi	Output: 600 dpi (AUTO/TEXT/PHOTO mode)
Gradation	Scanning: 256 Printing: 2 value	
Power supply	Local voltage $\pm 10\%$ (For this machine power supply requirements, see the name plate located on the back of the machine.)	
Power consumption	Max. 1.45 kW	
Overall dimensions	898 mm (W) x 615 mm (D) (35-11/32" (W) x 24-13/64" (D))	

Weight	Approx. 55 kg (121.3 lbs.) (Not includes toner cartridge)
Dimensions	623 mm (W) x 615 mm (D) x 786 mm (H) (24-17/32" (W) x 23-13/64" (D) x 30-15/16" (H))
Operating conditions	Temperature: 15°C to 30°C (59°F to 86°F), Humidity: 20% to 85%
Noise level	<p>Sound Power Level L_{wA}(1B=10dB)</p> <p>Copying: 6.3[B] (AR-M256)</p> <p>Copying: 6.5[B] (AR-M316)</p> <p>Standby: 3.2[B] (AR-M256, AR-M316)</p> <p>Sound Pressure Level L_{pA} (bystander positions)</p> <p>Copying: 47[dB(A)] (AR-M256)</p> <p>Copying: 51[dB(A)] (AR-M316)</p> <p>Standby: 16[dB(A)] (AR-M256, AR-M316)</p> <p>Sound Pressure Level L_{pA} (operator position)</p> <p>Copying: 50[dB(A)] (AR-M256)</p> <p>Copying: 52[dB(A)] (AR-M316)</p> <p>Standby: 16[dB(A)] (AR-M256)</p> <p>Standby: 17[dB(A)] (AR-M316)</p> <p>Noise emission measurement in accordance with ISO 7779.</p>
Emission concentration (measured according to RAL-UZ62: Editon Jan. 2002)	<p>Ozone: 0.02 mg/m³ or less</p> <p>Dust: 0.075 mg/m³ or less</p> <p>Styrene: 0.07 mg/m³ or less</p>

*1 First copy time is measured with original on the document glass in full ready condition with fuser at operating temperature and mirror motor at operating speed, actual time may vary based on environment conditions.

*2 The warm-up time may vary depending on the power-supply voltage, ambient temperature, and other operating conditions.



As a part of our policy of continuous improvement, SHARP reserves the right to make design and specification changes for product improvement without prior notice. The performance specification figures indicated are nominal values of production units. There may be some deviations from these values in individual units.

Data Issued: Feb. 1, 2007
MSDS No. F-01481

1. PRODUCT AND COMPANY IDENTIFICATION

Product Name : AR-310NT/ AR-310T/ AR-310ST/ AR-310FT/ AR-310ST-C/ AR-311ST-C
(Black Toner)

Supplier Identification : Sharp Corporation
22-22 Nagaike-cho, Abeno-ku, Osaka, Japan

Local suppliers are listed below. Please contact the nearest supplier for additional information.

Area	(Country)	(Name and Telephone Number)
North America	U.S.A.	Sharp Electronics Corporation Sharp Plaza, Mahwah, NJ Telephone number for information : 1-800-237-4277 Emergency telephone number : 1-800-255-3924
	Canada	Sharp Electronics of Canada Ltd. Telephone number for information : 905-890-2100 Emergency telephone number : 1-800-255-3924
Oceania	Australia	Sharp Corporation of Australia PTY. Ltd. No1 Huntingwood Drive Huntingwood Blacktown N.S.W. Telephone number for information : 1300-13-50-22
Europe	Germany	Sharp Electronics (Europe) GMBH Sonninstrasse 3, 20097 Hamburg Telephone number to access MSDS : 040-2376-2185 For more information : 040-2376-2613
	United Kingdom	Sharp Electronics (U. K.) Ltd. Telephone number for information : 08705-274-277
	France	Sharp Electronics France S.A. Telephone number for information : 01-49-90-34-00
	Austria	Sharp Electronics GMBH Telephone number for information : 01-727-19-0
	Italy	Sharp Electronics (Italy) S.P.A. Telephone number for information : 02895951
	Spain	Sharp Electronics (Espana) S.A. Telephone number for information : 93-581-97-00
	Netherlands	Sharp Electronics Benelux B.V. Telephone number for information : 30-6359500
	Sweden	Sharp Electronics Nordic AB Telephone number for information : 08-634-36-00
	Switzerland	Sharp Electronics (Schweiz) AG Telephone number for information : 01-846-6111
Middle East	U.A.E.	Sharp Middle East FZE P.O.Box 17115 Jebel Ali, Dubai Telephone number for information : 04-815311

2. COMPOSITION/INFORMATION ON INGREDIENTS

Substance[]	Preparation[X]					
Ingredient	CAS No.	Proportion	OSHA PEL	ACGIH TLV	MAK-TWA	NOHSC-TWA
Styrene-Acrylate copolymer	29497-14-1	85-95%	Not listed	Not listed	Not listed	Not listed
Carbon black	1333-86-4	5-10%	3.5mg/m ³	3.5mg/m ³	Not listed	3mg/m ³
Iron oxide	1309-38-2	1-5%	Not listed	Not listed	Not listed	Not listed
Metal Complex dye*	109125-51-1 } 84179-66-8 }	< 2%	0.5mg/m ³	0.5mg/m ³	Not listed	Not listed

* EC NO. : 400-110-2, Symbol letter : F, N, R Phrase : R11, R50/53

Data Issued: Feb. 1, 2007
MSDS No. F-01481

3. HAZARDS IDENTIFICATION

Most Important Hazards and Effects of the Products

Human Health Effects : There are no anticipated carcinogenic effects from exposure based on animal tests performed using toner. When used as intended according to instructions, studies do not indicate any symptoms of fibrosis will occur.

Environmental Effects : not toxic to aquatic organisms

Specific Hazards : Dust explosion (like most finely divided organic powders)

Directive 1999/45/EC(Europe): Not classified as dangerous

4. FIRST-AID MEASURES

Route(s) of Entry:	<u>Inhalation?</u>	<u>Skin?</u>	<u>Ingestion?</u>
	Yes	No	Possible but very unusual.

Inhalation : Remove to fresh air. If symptoms occur, consult medical personnel.

Skin Contact : Wash with soap and water for 15 minutes or until particle is removed.
If irritation does occur, consult medical personnel.

Eye Contact : Flush eyes immediately with water for 15 minutes. If irritation does occur, consult medical personnel.

Ingestion : Rinse with water and drink several glasses of water. If irritation or discomfort does occur, consult medical personnel.

5. FIRE-FIGHTING MEASURES

Extinguishing Media : Water, CO₂, foam and dry chemicals

Special Fire Fighting Procedures : None

Fire and Explosion Hazards : Toner material, like most finely divided organic powders, may form an explosive mixture.

6. ACCIDENTAL RELEASE MEASURES

Personal Precautions : None

Environmental Precautions : None

Methods for Cleaning Up : Wipe off with paper or cloth. Do not use vacuum cleaner when a large amount is released. It, like most finely divided organic powders, is capable of creating a dust explosion.

7. HANDLING AND STORAGE

Handling

Technical Measures : None

Precautions : None

Safe Handling Advice : Use of a dust mask is recommended when handling a large quantity of toner or during long term exposure, as with any non-toxic dust. Try not to disperse the particles.

Storage

Technical Measures : None

Storage Conditions : Keep container closed and Store in a cool and dry place.
Keep out of the reach of children.

Incompatible Products: None

8. EXPOSURE CONTROLS/PERSONAL PROTECTION

Engineering Measures

Ventilation : Not required under intended use.

Data Issued: Feb. 1, 2007
MSDS No. F-01481**Exposure Limit Values**

OSHA-PEL (USA) : 15mg/m³ (Total Dust) , 5mg/m³ (Respirable Dust)
 ACGIH-TLV (USA) : 10mg/m³ (Total Dust) , 3mg/m³ (Respirable Dust)

Personal Protective Equipment

Respiratory Protection : Not required under intended use.
 Hand Protection : Not required under intended use.
 Eye Protection : Not required under intended use.
 Skin Protection : Not required under intended use.
 Other Protective Equipment : Use of a dust mask and goggles are recommended when handling a large quantity of toner or during long term exposure, as with any non-toxic dust.

9. PHYSICAL AND CHEMICAL PROPERTIES**Appearance**

Physical State:Solid Form: Powder Color:Black Odor:odorless

Ph : Not applicable

Boiling/Melting Point : Not applicable

Softening Point (°C) : 100 - 130

Flash Point (°C) : Not applicable

Ignition Point (°C) : > 350

Explosion Properties : No data

Density (g/cm³) : 1.1 (bulk density : 0.35)

Solubility in Water : Negligible

10. STABILITY AND REACTIVITY

Stability : Stable

Hazardous Reactions : Dust explosion, like most finely divided organic powders.

Conditions to Avoid : Electric discharge, throwing into fire.

Materials to Avoid : Oxidizing Materials

Hazardous Decomposition Products : CO, CO₂ and NO_x

Further Information : None

11. TOXICOLOGICAL INFORMATION**Acute Toxicity**

Ingestion (oral) : LD₅₀ > 2000mg/kg (Rats)

Inhalation : No data

Eye irritation : Not an irritant (Rabbits)

Skin irritation : Not an irritant (Rabbits)

Skin sensitizer : No sensitization

Mutagenicity : Negative (Ames Test)

Carcinogenicity : In 1996 the IARC reevaluated carbon black as a Group 2B carcinogen (possible human carcinogen). This classification is given to chemicals for which there is inadequate human evidence, but sufficient animal evidence on which to base an opinion of carcinogenicity. The classification is based upon the development of lung tumors in rats receiving chronic inhalation exposures to free carbon black at levels that induce particle overload of the lung. Studies performed in animal models other than rats did not show any association between carbon black and lung tumors. Moreover, a two-year cancer bioassay using a typical toner preparation containing carbon black demonstrated no association between toner exposure and tumor development in rats.

Data Issued: Feb. 1, 2007
MSDS No. F-01481

Chronic Effect : In a study in rats of chronic inhalation exposure to a typical toner, a mild to moderate degree of lung fibrosis was observed in 92% of the rats in the high concentration (16mg/m³) exposure group, and a minimal to mild degree of fibrosis was noted in 22% of the animals in the middle (4mg/m³) exposure group, but no pulmonary change was reported in the lowest (1mg/m³) exposure group, the most relevant level to potential human exposures.

12. ECOLOGICAL INFORMATION

Ecotoxicity : On available data, toner is not harmful to aquatic organisms

13. DISPOSAL CONSIDERATIONS

Waste from Residues : Waste material may be dumped or incinerated under conditions which meet all federal, state and local environmental regulations.

Contaminated Packaging : Waste may be disposed or incinerated under conditions which meet all federal, state and local environmental regulations.

14. TRANSPORT INFORMATION

UN Classification : None
Not classified as hazardous for transport.

15. REGULATORY INFORMATION

US Information

TSCA (Toxic Substances Control Act) :

All chemical substances in this product comply with all applicable rules or order under TSCA.

SARA (Superfund Amendments and Reauthorization Act) Title III

302 Extreme Hazardous Substance: None

311/312 Hazard Classification : None

EU Information

1999/45/EC and 67/548/EEC

Symbol & Indication : Not required

R-Phrase : Not required

76/769/EEC : All chemical substances in this product comply with all applicable rules or order under 76/769/EEC.

16. OTHER INFORMATION

NFPA Rating (USA) : Health=1 Flammability=1 Reactivity=0

WHMIS Legislation (Canada) : This product is not a controlled product.

List of R phrases : R11 : Highly flammable

R50/53 : Very toxic to aquatic organisms, may cause long-term adverse effects in the aquatic environment.

References

IARC (1996) : IARC monographs on the Evaluation of the Carcinogenic Risk of Chemicals to Humans, Vol. 65, Printing Process And Printing Inks, Carbon Black and Some Nitro Compounds, Lyon, pp.149-261

H.Muhle, B.Bellmann, O.Creutzenberg, C.Dasenbrock, H.Ernst, R.Kilpper, J.C.MacKenzie, P.Morrow, U.Mohr, S.Takenaka, and R.Mermelstein (1991) Pulmonary Response to Toner upon Chronic Inhalation Exposure in Rats. Fundamental and Applied Toxicology 17, pp.280-299.

The information on this data sheet represents our current data and best opinion as to the proper use in handling of this product under normal conditions. However, all materials may present unknown hazards and should be used with caution. Although certain hazards are described herein, we do not guarantee that these are the only hazards which exist.

1. PRODUCT AND COMPANY IDENTIFICATION

Product Name : AR-271ND / AR-271DV / AR-271SD / AR-271SD-C (Black Developer)

Supplier Identification : Sharp Corporation

22-22 Nagaike-cho, Abeno-ku, Osaka, Japan

Local suppliers are listed below. Please contact the nearest supplier for additional information.

Area	(Country)	(Name and Telephone Number)
North America	U.S.A.	Sharp Electronics Corporation Sharp Plaza, Mahwah, NJ Telephone number for information : 1-800-237-4277 Emergency telephone number : 1-800-255-3924
	Canada	Sharp Electronics of Canada Ltd. Telephone number for information : 905-890-2100 Emergency telephone number : 1-800-255-3924
Oceania	Australia	Sharp Corporation of Australia PTY. Ltd. No1 Huntingwood Drive Huntingwood Blacktown N.S.W. Telephone number for information : 1300-13-50-22
Europe	Germany	Sharp Electronics (Europe) GMBH Sonninstrasse 3, 20097 Hamburg Telephone number to access MSDS : 040-2376-2185 For more information : 040-2376-2613
	United Kingdom	Sharp Electronics (U. K.) Ltd. Telephone number for information : 08705-274-277
	France	Sharp Electronics France S.A. Telephone number for information : 01-49-90-34-00
	Austria	Sharp Electronics GMBH Telephone number for information : 01-727-19-0
	Italy	Sharp Electronics (Italy) S.P.A. Telephone number for information : 02895951
	Spain	Sharp Electronics (Espana) S.A. Telephone number for information : 93-581-97-00
	Netherlands	Sharp Electronics Benelux B.V. Telephone number for information : 30-6359500
	Sweden	Sharp Electronics Nordic AB Telephone number for information : 08-634-36-00
Middle East	Switzerland	Sharp Electronics (Schweiz) AG Telephone number for information : 01-846-6111
	U.A.E.	Sharp Middle East FZE P.O.Box 17115 Jebel Ali, Dubai Telephone number for information : 04-815311

2. COMPOSITION/INFORMATION ON INGREDIENTS

Substance[] Preparation[X]

Ingredient	CAS No.	Proportion	OSHA PEL	ACGIH TLV	MAK-TWA	NOHSC-TWA
Iron powder	7439-89-6	> 90%	Not listed	Not listed	Not listed	Not listed
Styrene-Acrylate copolymer	29497-14-1	5-10%	Not listed	Not listed	Not listed	Not listed
Carbon black	1333-86-4	< 1%	3.5mg/m ³	3.5mg/m ³	Not listed	3mg/m ³

Data Issued: Aug. 1. 2003
MSDS No. F-31201

3. HAZARDS IDENTIFICATION

Most Important Hazards and Effects of the Products

Human Health Effects : There are no anticipated carcinogenic effects from exposure based on animal tests performed using toner. When used as intended according to instructions, studies do not indicate any symptoms of fibrosis will occur.

Environmental Effects : No data are available.

Specific Hazards : Dust explosion (like most finely divided organic powders)

Directive 1999/45/EC(Europe): Not classified as dangerous

4. FIRST-AID MEASURES

Route(s) of Entry: <u>Inhalation?</u>	<u>Skin?</u>	<u>Ingestion?</u>
No	No	Possible but very unusual.

Inhalation : Remove to fresh air. If symptoms occur, consult medical personnel.

Skin Contact : Wash with soap and water for 15 minutes or until particle is removed.

If irritation does occur, consult medical personnel.

Eye Contact : Flush eyes immediately with water for 15 minutes. If irritation does occur, consult medical personnel.

Ingestion : Rinse with water and drink several glasses of water . If irritation or discomfort does occur, consult medical personnel.

5. FIRE –FIGHTING MEASURES

Extinguishing Media : Water, CO₂, foam and dry chemicals

Special Fire fighting Procedures : None

Fire and Explosion Hazards : Toner material, like most finely divided organic powders, may form an explosive mixture.

6. ACCIDENTAL RELEASE MEASURES

Personal Precautions : None

Environmental Precautions : None

Methods for Cleaning Up : Wipe off with paper or cloth. Do not use vacuum cleaner when a large amount is released. It, like most finely divided organic powders, is capable of creating a dust explosion.

7. HANDLING AND STORAGE

Handling

Technical Measures : None

Precautions : None

Safe Handling Advice : Use of a dust mask is recommended when handling a large quantity of toner or during long term exposure, as with any non-toxic dust. Try not to disperse the particles.

Storage

Technical Measures : None

Storage Conditions : Keep container closed and Store in a cool and dry place.
Keep out of the reach of children.

Incompatible Products: None

8. EXPOSURE CONTROLS/PERSONAL PROTECTION

Engineering Measures

Ventilation : Not required under intended use.

Data Issued: Aug. 1. 2003
MSDS No. F-31201

Exposure limit values

OSHA-PEL (USA) : 15mg/m³ (Total Dust) , 5mg/m³ (Respirable Dust)
ACGIH-TLV (USA) : 10mg/m³ (Total Dust) , 3mg/m³ (Respirable Dust)

Personal Protective Equipment

Respiratory Protection : Not required under intended use.
Hand Protection : Not required under intended use.
Eye Protection : Not required under intended use.
Skin Protection : Not required under intended use.
Other Protective Equipment : Use of a dust mask and goggles are recommended when handling a large quantity of toner or during long term exposure, as with any non-toxic dust.

9. PHYSICAL AND CHEMICAL PROPERTIES**Appearance**

Physical State:Solid Form: Powder Color:Black Odor:odorless

Ph : Not applicable

Boiling/Melting Point : Not applicable

Flash Point (°C) : Not applicable

Ignition Point (°C) : No data

Explosion Properties : No data

Density (g/cm³) : 7.3 (bulk density : 2.0)

Solubility in water : Negligible

10. STABILITY AND REACTIVITY

Stability : Stable

Hazardous Reactions : Dust explosion, like most finely divided organic powders.

Conditions to Avoid : Electric discharge, throwing into fire.

Materials to Avoid : Oxidizing Materials

Hazardous Decomposition Products : CO, CO₂ and NO_x

Further Information : None

11. TOXICOLOGICAL INFORMATION**Acute Toxicity**

Ingestion (oral) : LD₅₀ > 2500mg/kg (Rats)

Inhalation : No data

Eye irritation : No data

Skin irritation : Not an irritant (Rabbits)

Skin sensitizer : No sensitization

Mutagenicity : Negative (Ames Test)

Carcinogenicity : In 1996 the IARC reevaluated carbon black as a Group 2B carcinogen (possible human carcinogen). This classification is given to chemicals for which there is inadequate human evidence, but sufficient animal evidence on which to base an opinion of carcinogenicity. The classification is based upon the development of lung tumors in rats receiving chronic inhalation exposures to free carbon black at levels that induce particle overload of the lung. Studies performed in animal models other than rats did not show any association between carbon black and lung tumors. Moreover, a two-year cancer bioassay using a typical toner preparation containing carbon black demonstrated no association between toner exposure and tumor development in rats.

Data Issued: Aug. 1. 2003
MSDS No. F-31201

Chronic Effect : In a study in rats of chronic inhalation exposure to a typical toner, a mild to moderate degree of lung fibrosis was observed in 92% of the rats in the high concentration (16mg/m³) exposure group, and a minimal to mild degree of fibrosis was noted in 22% of the animals in the middle (4mg/m³) exposure group, but no pulmonary change was reported in the lowest (1mg/m³) exposure group, the most relevant level to potential human exposures.

12. ECOLOGICAL INFORMATION

No data are available.

13. DISPOSAL CONSIDERATIONS

Waste from Residues : Waste material may be dumped or incinerated under conditions which meet all federal, state and local environmental regulations.

Contaminated Packaging : Waste may be disposed or incinerated under conditions which meet all federal, state and local environmental regulations.

14. TRANSPORT INFORMATION

UN Classification : None
Not classified as hazardous for transport.

15. REGULATORY INFORMATION

US Information

TSCA (Toxic Substances Control Act) :

All chemical substances in this product comply with all applicable rules or order under TSCA.

SARA (Superfund Amendments and Reauthorization Act) Title III

302 Extreme Hazardous Substance: None

311/312 Hazard Classification : None

EU Information

1999/45/EC and 67/548/EEC

Symbol & Indication : Not required

R-Phrase : Not required

76/769/EEC : All chemical substances in this product comply with all applicable rules or order under 76/769/EEC.

16. OTHER INFORMATION

NFPA Rating (USA) : Health=1 Flammability=1 Reactivity=0

WHMIS Legislation (Canada) : This product is not a controlled product.

References

IARC (1996) : IARC monographs on the Evaluation of the Carcinogenic Risk of Chemicals to Humans, Vol. 65, Printing Process And Printing Inks, Carbon Black and Some Nitro Compounds, Lyon, pp.149-261

H.Muhle, B.Bellmann, O.Creutzenberg, C.Dasenbrock, H.Ernst, R.Kilpper, J.C.MacKenzie, P.Morrow, U.Mohr, S.Takenaka, and R.Mermelstein (1991) Pulmonary Response to Toner upon Chronic Inhalation Exposure in Rats.

Fundamental and Applied Toxicology 17, pp.280-299.

The information on this data sheet represents our current data and best opinion as to the proper use in handling of this product under normal conditions. However, all materials may present unknown hazards and should be used with caution. Although certain hazards are described herein, we do not guarantee that these are the only hazards which exist.

INDEX

Symbols

[#/P] key 10, 55, 56

2 - 8

2 x 500-sheet paper feed unit 70, 77, 79

256MB expansion memory board 77

[2-SIDED COPY] key 21, 27, 28

500-sheet paper feed unit 70, 77, 79

512MB expansion memory board 77

8MB fax memory 77

A

ABCDEF configuration 54

AB series and inch series reference 6

[ACC.#-C] key 10, 57

Account number 57

Adjusting the exposure 29

Auditing mode 57

[AUTO IMAGE] key 30

Auto tray switching 54

Automatic ratio selection 30

Automatic two-sided copying

- Document glass 27

- RSPF 28

AZERTY configuration 54

B

Barcode font kit 77

[BINDING CHANGE] key 27

Bypass feed 26

Bypass tray 9, 26, 67, 76

Bypass tray extension 9, 18

[BYPASS TRAY] key 20

Bypass tray paper feed roller 76

Bypass tray paper guides 9

C

Card shot 50

[CARD SHOT] key 39, 50

Cautions on handling the machine 4

Cautions on using the machine 3

Centre tray 8, 69

Centre tray counter function 24

Changing a tray's paper tray

and paper size settings 19

Checking the toner quantity 75

Cleaning the machine

- Bypass tray paper feed roller 76

- Document glass 76

- RSPF 76

[CLEAR ALL] key 10, 14

[CLEAR] key 10, 22, 23

Clock 52

Color paper 15

Copy finishing functions

- Group copy 35

- Offset function 35

- Sort copy 35

- Staple sort 37

[COPY] key 21, 73, 75

Copy number display 21

Copy ratio display 21

[COPY RATIO] key 21, 31, 32

Cover copy 48

[COVER] key 39, 49

Custom settings 52

[CUSTOM SETTINGS] key 10, 19, 20, 53

D

[DELETE] key 56

[DETAIL] key 12

Disabling of two-sided printing on

letterhead paper 54

Display contrast 52, 54

Display message 59

Display switching key 12

Document cover 8, 22, 24, 77

Document feeder cover 66, 80

Document feeder tray 23, 66, 80

Document glass 8

Document transport cover 66, 80

Document transport cover knob 66, 80

Dual page copy 43

[DUAL PAGE COPY] key 39, 43

E

Enlargement key 31

Envelope 15, 16

Erase copy 42

[ERASE] key 39, 42

Erase mode

- Centre erase 42

- Edge erase 42

- Edge+centre erase 42

Erase width 42

Error message 59

Exit area 66, 80

Exposure adjustment 29

Exposure display 21

[EXPOSURE] key 21, 29

Exposure value guidelines 29

Extra image adjust 26

F

Facsimile expansion kit 77

[FAX JOB] key 12

[FAX] key

- DATA indicator 10

- LINE indicator 10

Finisher 37, 71, 74, 77, 78

Front cover 8, 67, 68, 73

Fusing unit paper guide 9, 68

Fusing unit release lever 9, 68

G	
Greyed out	11
Group copy.....	35
[GROUP] key	36
H	
Handles	8
Heavy paper.....	15
How to place the original	
- Document glass	22
- RSPF	23
I	
Icon (Job status screen).....	12
Important points when inserting paper	
in the bypass tray	18
Important points when selecting an installation site ..	3
[INFORMATION] key	65
Initial settings	14
[INTERRUPT] key	10, 34
Interrupting copy	34
J	
[JOB BUILD] key	39, 45
Job build mode.....	23, 45
Job list.....	12
Job program	
- Deleting.....	56
- Executing	56
- Storing.....	55
Job separator tray	8, 77
[JOB STATUS] key	10, 12
Job status screen	12
L	
Label	15
Laser information	4
Layout	46
Letterhead paper.....	15, 16, 27
List print.....	52, 54
Loading paper	15
Loading paper in the bypass tray	18
Loading the paper in the paper tray	17
M	
Main screen of copy mode.....	21
[MANUAL] key.....	47
Manual ratio selection	31
Margin shift copy	41
[MARGIN SHIFT] key.....	39, 41
Material safety data sheet	83
[MENU] key	31
Message display	21
Misfed original	66
Misfeed in an output tray.....	71
Misfeed in the bypass tray	67
Misfeed in the centre tray.....	69
Misfeed in the fusing area	68
Misfeed in the lower paper tray	70
Misfeed in the machine	67
Misfeed in the paper feed area	67
Misfeed in the upper exit area.....	71
Misfeed in the upper paper tray	69
Misfeed removal	
- Bypass tray	67
- Centre tray	69
- Lower paper tray	70
- Machine.....	67
- Output tray	71
- RSPF.....	66
- Upper exit tray.....	71
- Upper paper tray	69
Misfeed removal guidance	65
Mixed feeding	25
Mode select keys	10
Mode switching key	12
Multi shot copy	46
[MULTI SHOT] key.....	39, 46
N	
Network scanner expansion kit	77
Normal copying	
- Document glass	22
- RSPF.....	23
Number of pages fed through the RSPF	54
Number of pages sent using the	
network scanner function	54
Number of sent and received fax pages	54
Number of times the stapler was used.....	54
Number of two-sided copies.....	54
Numeric keys	10
O	
Offset function	35, 36
Offset tray.....	35, 72, 78
Operation panel.....	8
Optional equipment	77
Orientation of the original (Staple sort)	37
Original feed display.....	21
Original guides	8
Original image type	
- Photo.....	29
- Text	29
- Text/photo	29
Original size	22, 23, 24, 47
Original size display	21
[ORIGINAL SIZE] key	39, 47
Originals that can be used in the RSPF	24
[OUTPUT] key.....	21, 35, 36, 38
Output tray	71
P	
Pamphlet copy	44
[PAMPHLET COPY] key	39, 44
Paper.....	15
Paper capacity	15
Paper guide	72
Paper misfeeds	63
Paper select display	21
[PAPER SELECT] key	20, 21, 22, 23, 26
Paper size	15, 19
Paper size card	17
Paper size display	21

Paper tray.....	9, 15, 17, 19, 69
Paper type.....	15, 19, 20
Paper weight	15
Part names and functions	
- Operation panel	10
Peripheral devices.....	77
Photoconductive drum	9, 67
Plain paper	15
Points to note when making copies.....	24
Power off	13
Power on	13
Power outlet	4
Power save modes	
- Auto power shut-off mode.....	14
- Preheat mode	14
Power switch	8, 13
Preset enlargement ratios	31
[PRINT JOB] key.....	12
[PRINT] key	
- DATA indicator.....	10
- ONLINE indicator	10
Printer expansion kit.....	77
[PRIORITY] key.....	12
PS3 expansion kit	77

Q

QWERTY configuration.....	54
---------------------------	----

R

[READ-END] key.....	36, 38, 45, 46
Recycled paper	15
Reduction key	31
Reduction/enlargement/zoom	30
Release roller.....	66
Replacing the toner cartridge	73
Reversing tray	66, 80
Roller rotating knob	9, 67, 68
Rotation copying	25
RSPF	23, 24, 66, 80

S

[SCAN] key	
- DATA indicator.....	10
[SCAN TO] key.....	12
Selecting the original image type	29
Setting the paper type in the bypass tray	
- [CUSTOM SETTINGS] key	20
- [PAPER SELECT] key	20
Shift direction	41
Side cover	9, 68
Side cover handle	9
Sort copy	35
[SORT] key.....	36
Special modes	
- Card shot	50
- Cover copy.....	48
- Dual page copy	43
- Erase copy	42
- Job build mode.....	45
- Margin shift copy	41
- Multi shot copy	46

- Original size	47
- Pamphlet copy	44
[SPECIAL MODES] key	21, 39, 40
Special papers	
- Envelope	16
- Letterhead paper.....	16
Special papers	26
Specifications	81
Staple box	74
Staple cartridge	74
Staple cartridge replacement	74
Staple cover	75, 78
Staple jam removal	75
Staple sort.....	37
[STAPLE SORT] key.....	38
Stapler compiler	72
Stapler compiler cover	71
Stapler cover	74
Stapling positions	37
[START] key.....	10, 22, 23
[STOP/DELETE] key.....	12
Storage of supplies	80
[STORE/DELETE] key	55, 56
Stream feeding mode.....	23

T

Thin paper	15
Toner cartridge	9, 73
Toner cartridge lock release lever	9, 73
Top cover	78
Top tray	72, 78
Total count	52, 54, 75
Total number of copies and printed pages.....	54
Touch panel	10, 11
Transparency film.....	15, 16, 27
Tray number.....	15, 19
Tray settings.....	19, 20, 52, 54
[TRAY SETTINGS] key	19, 20
Troubleshooting	61

U

Upper exit area.....	71
Upper right side cover	9, 71
Using the touch panel	11

W

Warm-up	13
---------------	----

X

[X] key	33
XY ZOOM copying	32
[XY ZOOM] key	32

Y

[Y] key	33
---------------	----

INDEX BY PURPOSE

Preparations

Bypass tray, loading paper in	18
Documet cover, removing	24
Initial settings, returning to	14
Paper size, changing	19
Paper type, changing	19
Paper, loading	17
Power, turning off	13
Power, turning on	13

Making copies

Auditing mode, copying when enabled	57
Automatic two-sided copying	
- Document glass	27
- RSPF	28
Bypass tray, copying from	26
Copy run, stopping	22, 23
Copying	
- Document glass	22
- RSPF	23
Document glass, copying from	22
Enlarging/reducing copies	
- Automatic ratio selection	30
- Manual ratio selection	31
- XY zoom copying	32
Exposure, adjusting	29
Exposure, selecting	29
Image orientation, changing	27, 28
Interrupt copying	34
Mixed feeding	25
Original image type, selecting	29
Paper size (tray), selecting manually	22
RSPF, copying from	23
Special paper, copying on	26
Stream feeding mode, using	23

Using convenient copy functions

Cover, adding to copies	48
Dual page copying	43
Erase copying	42
Group copying, using	35
Large number of originals, copying	45
Margin, creating	41
Multi shot copying	46
Offset function, using	35
Original size, specifying	47
Pamphlet copying	44
Selecting finishing functions	
- Group copying	35
- Offset function	35
- Sort copying	35
- Staple sort function	37
Sort copying, using	35

Special modes, using

- Card shot copy	50
- Cover copy	48
- Dual page copy	43
- Erase copy	42
- Job build mode	45
- Margin shift copy	41
- Multi shot copy	46
- Original size	47
- Pamphlet copy	44
Staple sort function, using	37

Making the machine easier to use

Canceling a job	12
Canceling a job in progress	12
Date and time, setting	54
Deleting a job	12
Display contrast, adjusting	54
Job details, displaying	12
Job program, deleting	56
Job program, executing	56
Job program, storing	55
Keyboard, changing	54
Lists, printing	54
Priority, giving to a specified job	12
Total count, displaying	54
Trays, configuring settings	54
User settings, configuring	52

Troubleshooting and maintenance

Cleaning the machine	76
Misfeeds, removing	
- Bypass tray	67
- Centre tray	69
- Lower paper tray	70
- Machine	67
- Output tray	71
- RSPF	66
- Upper exit area	71
- Upper paper tray	69
Staple cartridge, replacing	74
Staple jams, removing	75
Toner cartridge, replacing	73
Toner, checking	75
Total count, checking	75
Troubleshooting	61

Trademark acknowledgments

The following trademarks and registered trademarks are used in conjunction with the machine and its peripheral devices and accessories.

- Microsoft®, Windows®, Windows® 98, Windows® Me, Windows NT® 4.0, Windows® 2000, Windows® XP, Windows Server® 2003 and Internet Explorer® are registered trademarks or trademarks of Microsoft Corporation in the U.S.A. and other countries.
- PostScript is a registered trademark of Adobe Systems Incorporated.
- Macintosh, Mac OS, AppleTalk, EtherTalk, LaserWriter, and Safari are registered trademarks or trademarks of Apple Computer, Inc.
- Netscape Navigator is a trademark of Netscape Communications Corporation.
- Adobe, the Adobe logo, Acrobat, the Adobe PDF logo, and Reader are registered trademarks or trademarks of Adobe Systems Incorporated in the United States and other countries.
- PCL is a registered trademark of the Hewlett-Packard Company.
- IBM, PC/AT, and PowerPC are trademarks of International Business Machines Corporation.
- Sharpdesk is a trademark of Sharp Corporation.
- All other trademarks and copyrights are the property of their respective owners.

Candid and Taffy are trademarks of Monotype Imaging, Inc. registered in the United States Patent and Trademark Office and may be registered in certain jurisdictions. CG Omega, CG Times, Garamond Antiqua, Garamond Halbfett, Garamond Kursiv, Garamond and Halbfett Kursiv are trademarks of Monotype Imaging, Inc. and may be registered in certain jurisdictions. Albertus, Arial, Coronet, Gill Sans, Joanna and Times New Roman are trademarks of The Monotype Corporation registered in the United States Patent and Trademark Office and may be registered in certain jurisdictions. Avant Garde, ITC Bookman, Lubalin Graph, Mona Lisa, Zapf Chancery and Zapf Dingbats are trademarks of International Typeface Corporation registered in the United States Patent and Trademark Office and may be registered in certain jurisdictions. Clarendon, Eurostile, Helvetica, Optima, Palatino, Stempel Garamond, Times and Univers are trademarks of Heidelberger Druckmaschinen AG, which may be registered in certain jurisdictions, exclusively licensed through Linotype Library GmbH, a wholly owned subsidiary of Heidelberger Druckmaschinen AG. Apple Chancery, Chicago, Geneva, Monaco and New York are trademarks of Apple Computer Inc. and may be registered in certain jurisdictions. HGGothicB, HGMinchoL, HGPGothicB and HGPMinchoL are trademarks of Ricoh Company, Ltd. and may be registered in some jurisdictions. Wingdings is a registered trademark of Microsoft Corporation in the United States and other countries. Marigold and Oxford are trademarks of Arthur Baker and may be registered in some jurisdictions. Antique Olive is a trademark of Marcel Olive and may be registered in certain jurisdictions. Hoefler Text is a trademark of Johnathan Hoefler and may be registered in some jurisdictions. ITC is a trademark of International Typeface Corporation registered in the United States Patent and Trademark Office and may be registered in certain jurisdictions. Agfa is a trademark of the Agfa-Gevaert Group and may be registered in certain jurisdictions. Intellifont, MicroType and UFST are trademarks of Monotype Imaging, Inc. registered in the United States Patent and Trademark Office and may be registered in certain jurisdictions. Macintosh and TrueType are trademarks of Apple Computer Inc. registered in the United States Patent and Trademark Office and other countries. PostScript is a trademark of Adobe Systems Incorporated and may be registered in some jurisdictions. HP, PCL, FontSmart and LaserJet are trademarks of Hewlett-Packard Company and may be registered in some jurisdictions. The Type 1 processor resident in Monotype Imaging's UFST product is under license from Electronics For Imaging, Inc. All other trademarks are the property of their respective owners.

Connectors

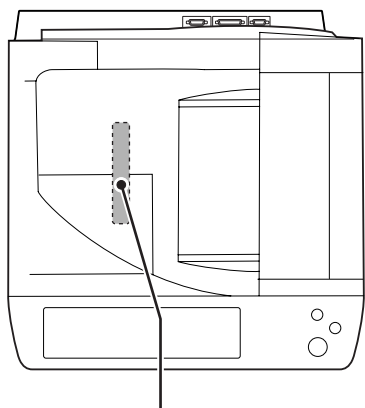

VAROITUS!
 LAITTEEN KÄYTTÄMINEN
 MUULLA KUIN TÄSSÄ
 KÄYTTÖOHJEESSA MAINITULLA
 TAVALLA SAATTAA ALTISTAA
 KÄYTTÄJÄN
 TURVALLISUUSLUOKAN 1
 YLITTÄVÄLLE
 NÄKYMÄTTÖMÄLLE
 LASERSÄTEILYLLE.

VARNING
 OM APPARATEN ANVÄNDS PÅ
 ANNAT SÄTT ÄN I DENNA
 BRUKSANVISNING
 SPECIFICERATS, KAN
 ANVÄNDAREN UTSÄTTAS FÖR
 OSYNLIG LASERSTRÅLNING,
 SOM ÖVERSKRIDER GRÄNSEN
 FÖR LASERKLASS 1.

	Laserstrahl	CAUTION INVISIBLE LASER RADIATION WHEN OPEN AND INTERLOCKS DEFEATED. AVOID EXPOSURE TO BEAM. VORSICHT UNSICHTBARE LASERSTRAHLUNG WENN ABDECKUNG GEÖFFNET UND SICHERHEITSVERRIEGELUNG ÜBERÜCKT. NICHT DEM STRAHL AUSSETZEN. ADVARSEL USYNLIG LASERSTRÅLNING VED ÅBNING, NÅR SIKKERHEDSafbrydere ER UDE AF FUNKTION. UNDGÅ UDSÆTTELSE FOR STRÅLING.	ADVERSEL OSYNLIG LASERSTRÅLNING NÅR DEKSEL ÅPNES OG SIKKERHEDSLÅS BRYTES. UNNGÅ EKSPONERING FOR STRÅLEN. VARNING OSYNLIG LASERSTRÅLNING NÅR DENNA DEL ÄR ÖPPNAD OCH SPÄRRAR ÄR URKÖPLADE. STRÅLEN ÄR FÄRLIG. BETRÄKTA EJ STRÅLEN. VARO! AVATTAESSA JA SUOJALUKITUS OHTETTAESSA OLET ALLTIIN NÄKYMÄTTÖMÄ LASERSÄTEILYLLE, ÄLÄ KÄTSO SÄTEESEEN.

Caution:
 This connector is only intended for service purposes.
 Any connection to this terminal may cause malfunctions
 of the copy machine.
Instruction for service technician:
 The cable length for the service terminal has to be less
 than 3 m (10 feet).

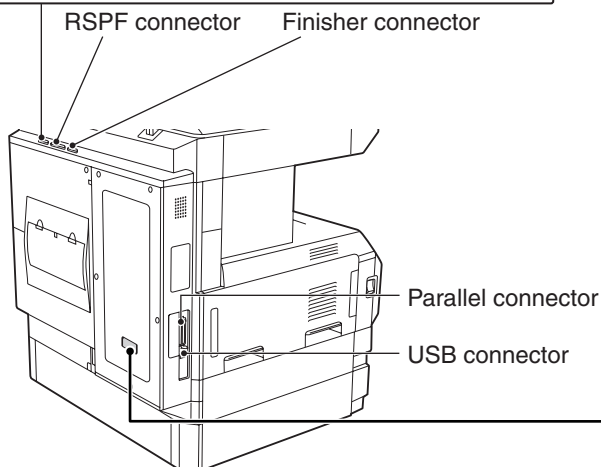

LUOKAN 1 LASERLAITE

KLASS 1 LASERAPPARAT

**CLASS 1
 LASER PRODUCT
 LASER KLASSE 1**

INFORMATION ON DISPOSAL

A. Information on Disposal for Users (private households)

1. In the European Union

Attention: If you want to dispose of this equipment, please do not use the ordinary dust bin!

Used electrical and electronic equipment must be treated separately and in accordance with legislation that requires proper treatment, recovery and recycling of used electrical and electronic equipment.

Following the implementation by member states, private households within the EU states may return their used electrical and electronic equipment to designated collection facilities free of charge*. In some countries* your local retailer may also take back your old product free of charge if you purchase a similar new one.

*) Please contact your local authority for further details.

If your used electrical or electronic equipment has batteries or accumulators, please dispose of these separately beforehand according to local requirements.

By disposing of this product correctly you will help ensure that the waste undergoes the necessary treatment, recovery and recycling and thus prevent potential negative effects on the environment and human health which could otherwise arise due to inappropriate waste handling.

2. In other Countries outside the EU

If you wish to discard this product, please contact your local authorities and ask for the correct method of disposal. For Switzerland: Used electrical or electronic equipment can be returned free of charge to the dealer, even if you don't purchase a new product. Further collection facilities are listed on the homepage of www.swico.ch or www.sens.ch.

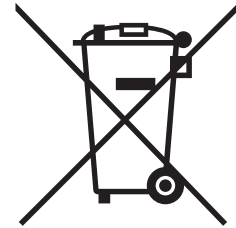

Attention: Your product is marked with this symbol. It means that used electrical and electronic products should not be mixed with general household waste. There is a separate collection system for these products.

B. Information on Disposal for Business Users.

1. In the European Union

If the product is used for business purposes and you want to discard it:

Please contact your SHARP dealer who will inform you about the take-back of the product. You might be charged for the costs arising from take-back and recycling. Small products (and small amounts) might be taken back by your local collection facilities.

For Spain: Please contact the established collection system or your local authority for take-back of your used products.

2. In other Countries outside the EU

If you wish to discard of this product, please contact your local authorities and ask for the correct method of disposal.

SHARP ELECTRONICS (Europe) GmbH
Sonninstraße 3, D-20097 Hamburg

SHARP[®]

SHARP CORPORATION

This manual has been printed using a vegetable-based soy oil ink
to help protect the environment.

Printed on 100% post-consumer recycled paper



PRINTED IN CHINA
2007C KS2
TINSE1765QSZZ